

USER MANUAL



Handheld PID Monitors

Honeywell

CONTENTS

Chapter 1 - Introduction	7
Product registration	7
Standards and certifications	7
Safety	9
Read before operating	10
Proper Product Disposal At End Of Life	11
Standard package contents	14
Chapter 2 - General information	15
Key features	15
Physical description	16
Chapter 3 - Charging the battery	17
Charging a spare rechargeable battery	19
Replacing rechargeable Li-Ion battery	19
Low voltage warning	19
Clock battery	20
Data protection while power is off	20
Alkaline battery pack	20
Chapter 4 - Basic operation	21
Turning the instrument on	21
Turning the instrument off	21
Chapter 5 - User interface	22
Display	24
Icons	26
Chapter 6 - Operating the instrument	27
Turning the instrument on	27
Turning the instrument off	27
Auto-zero at startup	28
Operating the built-in flashlight	28

Pump status	29
Calibration status	29
Bump status	30
Glance mode	30
Enter glance mode	30
Glance mode screens	31
Exit glance mode	31
Reverse direction navigation	32
Policy enforcement	32
Setting policy enforcement	33
Chapter 7 - Operating modes	36
MiniRAE 3000+ & ppbRAE 3000+	36
Basic user level/hygiene mode	37
UltraRAE 3000+	38
Chapter 8 - UltraRAE 3000+ operation	40
Compound-specific measurement	40
Measurement phases	40
Performing a measurement	40
Separation tube preparation	42
Inserting the separation tube	43
Measuring	44
Chapter 9 - VOC operation - UltraRAE3000+	47
Basic user level/hygiene mode (Default settings)	47
Basic operation – MiniRAE 3000+	48
Chapter 10 - Alarm signals	49
Alarm signal summary	49
Preset alarm limits & calibration	50
Testing the alarm	50
Integrated sampling pump	51
Backlight	51

Datalogging	51
Datalogging event	51
Datalogging sample	51
Auto/manual/snapshot datalogging	52
Chapter 11 - Standard kit & accessories	53
Accessories	53
AC adapter (battery charger)	55
Alkaline battery adapter	56
External filter	57
Optional accessories	58
Calibration adapter	58
Calibration regulator	58
Organic vapor zeroing kit	58
AutoRAE 2 automatic test & calibration system	58
Chapter 12 - Calibration	59
Standard two-point calibration	59
Entering calibration	60
Zero (Fresh Air) Calibration	61
Span calibration	62
Exiting two-point calibration in basic user level	63
Three-point calibration	64
Span 2 calibration	65
Exiting three-point calibration	66
Chapter 14 - Bump test	67
Chapter 15 - Programming mode	68
Entering programming mode	69
Programming mode menus	71
Exiting programming mode	72
Navigating programming mode menus	72
Reverse direction – menu selection	73
Calibration	73
Measurement	75

Datalog	82
Monitor setup	85
Chapter 16 - Hygiene mode	93
Basic user level & hygiene mode	93
Entering search mode from hygiene mode	94
Chapter 17 - Advanced user level	95
Advanced user level & hygiene mode	95
Basic user level & search mode	96
Advanced user level & search mode	97
Chapter 18 - Diagnostic mode	98
Entering diagnostic mode	98
Adjusting the pump stall threshold	99
Testing the humidity sensor	100
Exiting diagnostic mode	101
Chapter 19 - Transferring data	102
Downloading the datalog to a PC	102
Uploading firmware to the instrument from a PC	103
Chapter 20 - Maintenance	104
Battery charging & replacement	104
Replacing the Li-ion battery	105
Replacing the alkaline battery adapter	106
PID sensor & lamp cleaning/replacement	107
Cleaning the PID sensor	110
Cleaning the lamp housing or changing the lamp	110
Determining the lamp type	111
Sampling pump	112
Cleaning the instrument	112
Special servicing note	112
Chapter 21 - Specifications	113
MiniRAE Lite+ specifications	113

MiniRAE 3000+ specifications	115
ppbRAE 3000+ specifications	118
UltraRAE 3000+ specifications	121
Chapter 22 - Troubleshooting	124

1 INTRODUCTION

Product registration

Register your product online by visiting:

<https://sps.honeywell.com/us/en/support/safety/hgas-product-registration>

By registering your product, you can:

- Receive notification of product upgrades or enhancements
- Be alerted to Training classes in your area
- Take advantage of Honeywell special offers and promotions

Standards and certifications

Intrinsic Safety

US and Canada: Class I, Division 1, Groups A,B,C,D

ATEX

  II 2G Ex ia IIC T4 Gb
Ex ia IIB T4 Gb

Sira 17ATEX2082X

IECEX

CSA 10.0005X Ex ia IIC T4 Gb
Ex ia IIB T4 Gb

EX ia IIC T4 Gb (with bat pack 059-3051-000)

EX ia IIB T4 Gb (with bat pack 059-3052-000)

UK
CA
8501
CSAE 21UKEX2051X

CSAE 21UKEX2051X

Temperature:

-20° C to 50° C (-4° to 122° F)

Humidity:

0% to 95% relative humidity (non-condensing)

FCC Information

Contains FCC ID: SU3RMBLEB or SU3RM900 or SU3RMWIFIC or SU3RMLORAB, depends on what radio is assembled

The enclosed device complies with part 15 of the FCC rules. Operation is subject to the following conditions: (1) This device may not cause harmful interference, and (2) This device must accept any interference received, including interference that may cause undesired operation.

Wireless Approval For UAE In Middle East

TRA REGISTERED No: ER36153/14 or ER36153/15

DEALER No.: HONEYWELL INTERNATIONAL MIDDLE EAST – LTD – DUBAI BR

Wireless Approval For QATAR In Middle East

ictQATAR

Type Approval Reg. No.: R-4466 or R-4635



Safety



WARNING

This Manual must be carefully read by all individuals who have or will have the responsibility of using, maintaining, or servicing this product. The product will perform as designed only if it is used, maintained, and serviced in accordance with the manufacturer's instructions. The user should understand how to set the correct parameters and interpret the obtained results.

For safety reasons, this equipment must be operated and serviced by qualified personnel only. Read and understand the instruction manual completely before operating or servicing.



AVERTISSEMENT

Pour des raisons de sécurité, cet équipement doit être utilisé, entretenu et réparé uniquement par un personnel qualifié. Étudier le manuel d'instructions en entier avant d'utiliser, d'entretenir ou de réparer l'équipement.

Read before operating

This manual must be carefully read by all individuals who have or will have the responsibility of using, maintaining, or servicing this product. The product will perform as designed only if it is used, maintained, and serviced in accordance with the manufacturer's instructions. The user should understand how to set the correct parameters and interpret the obtained results.



CAUTION

To reduce the risk of electric shock, turn the power off before opening this instrument or performing service. Never operate the instrument when the instrument is open. Service this product only in an area known to be non-hazardous.



WARNING

ATEX: To reduce the risk of electrostatic ignition, do not use the instrument without the rubber boot in place.

STATIC HAZARD: Clean only with a damp cloth.

For safety reasons, this equipment must be operated and serviced by qualified personnel only. Read and understand instruction manual completely before operating or servicing.

USE ONLY RAE SYSTEMS BY HONEYWELL BATTERY PACKS, PART NUMBERS 059-3051-000, 059-3052-000, AND 059-3054-000. THIS INSTRUMENT HAS NOT BEEN TESTED IN AN EXPLOSIVE GAS/AIR ATMOSPHERE HAVING AN OXYGEN CONCENTRATION GREATER THAN 21%. SUBSTITUTION OF COMPONENTS MAY IMPAIR INTRINSIC SAFETY. RECHARGE BATTERIES ONLY IN NON-HAZARDOUS LOCATIONS.

DO NOT MIX OLD AND NEW BATTERIES OR BATTERIES FROM DIFFERENT MANUFACTURERS.

THE CALIBRATION OF ALL NEWLY PURCHASED HONEYWELL INSTRUMENTS SHOULD BE TESTED BY EXPOSING THE SENSOR(S) TO KNOWN CONCENTRATION CALIBRATION GAS BEFORE THE INSTRUMENT IS PUT INTO SERVICE.

FOR MAXIMUM SAFETY, THE ACCURACY OF THE INSTRUMENT SHOULD BE CHECKED BY EXPOSING IT TO A KNOWN CONCENTRATION CALIBRATION GAS BEFORE EACH DAY'S USE.

DO NOT USE USB/PC COMMUNICATION IN HAZARDOUS LOCATIONS.



AVERTISSEMENT

DANGER RISQUE D'ORIGINE ELECTROSTATIQUE: Nettoyer uniquement avec un chiffon humide.

Pour des raisons de sécurité, cet équipement doit être utilisé, entretenu et réparé uniquement par un personnel qualifié. Étudier le manuel d'instructions en entier avant d'utiliser, d'entretenir ou de réparer l'équipement.

Utiliser seulement l'ensemble de batterie RAE Systems par Honeywell, la référence 059-3051-000 au 059-3052-000 au 059-3054-000. Cet instrument n'a pas été essayé dans une atmosphère de gaz/air explosive ayant une concentration d'oxygène plus élevée que 21%. La substitution de composants peut compromettre la sécurité intrinsèque. Ne charger les batteries que dans emplacements désignés non-dangereuse.

Ne pas mélanger les anciennes et les nouvelles batteries, ou bien encore les batteries de différents fabricants.

La calibration de tous les instruments de Honeywell doit être testée en exposant l'instrument à une concentration de gaz connue par une procédure de recalibration avant de mettre en service l'instrument pour la première fois.

Pour une sécurité maximale, la sensibilité de l'instrument doit être vérifiée en exposant l'instrument à une concentration de gaz connue par une procédure de recalibration avant chaque utilisation journalière.

Ne pas utiliser de connexion USB/PC en zone dangereuse.

Proper Product Disposal At End Of Life



EU Directive 2012/19/EU: Waste Electrical and Electronic Equipment (WEEE)

This symbol indicates that the product must not be disposed of as general industrial or domestic waste. This product should be disposed of through suitable WEEE disposal facilities. For more information about disposal of this product, contact your local authority, distributor, or the manufacturer



CAUTION

This device complies with Part 15 of the FCC Rules / Industry Canada license-exempt RSS standard(s). Operation is subject to the following two conditions: (1) this device may not cause harmful interference, and (2) this device must accept any interference received, including interference that may cause undesired operation.

Le présent appareil est conforme aux CNR d'Industrie Canada applicables aux appareils radio exempts de licence. L'exploitation est autorisée aux deux conditions suivantes : (1) l'appareil ne doit pas produire de brouillage, et (2) l'utilisateur de l'appareil doit accepter tout brouillage radioélectrique subi, même si le brouillage est susceptible d'en compromettre le fonctionnement.

Changes or modifications not expressly approved by the party responsible for compliance could void the user's authority to operate the equipment.

This equipment has been tested and found to comply with the limits for a Class B digital device, pursuant to part 15 of the FCC Rules. These limits are designed to provide reasonable protection against harmful interference in a residential installation. This equipment generates, uses, and can radiate radio frequency energy and, if not installed and used in accordance with the instructions, may cause harmful interference to radio communications. However, there is no guarantee that interference will not occur in a particular installation. If this equipment does cause harmful interference to radio or television reception, which can be determined by turning the equipment off and on, the user is encouraged to try to correct the interference by one or more of the following measures:

- Reorient or relocate the receiving antenna.
- Increase the separation between the equipment and receiver.
- Connect the equipment into an outlet on a circuit different from that to which the receiver is connected.
- Consult the dealer or an experienced radio/TV technician for help.

Under Industry Canada regulations, this radio transmitter may only operate using an antenna of a type and maximum (or lesser) gain approved for the transmitter by Industry Canada. To reduce potential radio interference to other users, the antenna type and its gain should be so chosen that the equivalent isotropically radiated power (e.i.r.p.) is not more than that necessary for successful communication.

Conformément à la réglementation d'Industrie Canada, le présent émetteur radio peut fonctionner avec une antenne d'un type et d'un gain maximal (ou inférieur) approuvé pour l'émetteur par Industrie Canada. Dans le but de réduire les risques de brouillage radioélectrique à l'intention des autres utilisateurs, il faut choisir le type d'antenne et son gain de sorte que la puissance isotrope rayonnée équivalente (p.i.r.e.) ne dépasse pas l'intensité nécessaire à l'établissement d'une communication satisfaisante.

IMPORTANT! BUMP TEST THE MONITOR BEFORE EACH DAY'S USE

Prior to each day's use, every gas detection monitor should be bump tested to confirm the response of all sensors and activation of all alarms by exposing the monitor to a concentration of target gas that exceeds the low alarm set point. A bump test is also recommended if the monitor has been subjected to physical impact, liquid immersion, an Over Limit alarm event, or custody changes, or anytime the monitor's performance is in doubt.

To ensure greatest accuracy and safety, only bump test and calibrate in a fresh air environment.

The monitor should be calibrated every time it does not pass a bump test, but no less frequently than every six months, depending on use and exposure to gas and contamination, and its operational mode.

- Calibration intervals and bump test procedures may vary due to national legislation.
- Honeywell recommends using calibration gas cylinders containing the gas that is appropriate to the sensor you are using, and in the correct concentration.

Special Notes



When the instrument is taken out of the transport case and turned on for the first time, there may be some residual organic or inorganic vapor trapped inside the detector chamber. The initial PID sensor reading may indicate a few ppm. Enter an area known to be free of any organic vapor and turn on the instrument. After running for several minutes, the residual vapor in the detector chamber will be cleared and the reading should return to zero.



The battery of the instrument discharges slowly even if it is turned off. If the instrument has not been charged for 5 to 7 days, the battery voltage will be low. Therefore, it is a good practice to always charge the instrument before using it. It is also recommended to fully charge the instrument for at least 10 hours before first use. Refer to this User Guide's section on battery charging for more information on battery charging and replacement.

Standard package contents

- Instrument
- Calibration Kit
- Charging cradle
- AC/DC Adapter
- Alkaline Battery Adapter
- Data Cable
- Quick Start Guide

2

GENERAL INFORMATION

The compact instrument is designed as a broadband VOC gas monitor and datalogger for work in hazardous environments. It monitors Volatile Organic Compounds (VOC) using a photoionization detector (PID) with a 9.8 eV, 10.6 eV, or 11.7eV gas-discharge lamp. The instrument consists of a PID with associated microcomputer and electronic circuit. The unit is housed in a rugged case with a backlit LCD and 3 keys to provide easy user interface. It also has a built-in flashlight for operational ease in dark locations.

Key features

Lightweight and Compact

- Compact, lightweight, rugged design
- Built-in sample draw pump

Dependable and Accurate

- Up to 16 hours of continuous monitoring with rechargeable battery pack
- Designed to continuously monitor VOC vapor at parts-per-million (ppm) and/or parts-per-billion (ppb) levels

User-friendly

- Preset alarm thresholds for STEL, TWA, low- and high-level peak values.
- Audio buzzer and flashing LED display are activated when the limits are exceeded.

Datalogging Capabilities

- 260,000-point datalogging storage capacity for data download to PC

Physical description

The main components of the portable VOC monitoring instrument include:

- Three keys for user interaction with the instrument: 3 operation/programming keys for normal operation or programming
- LCD display with back light for direct readout and calculated measurements
- Built-in flashlight for illuminating testing points in dark environments
- Buzzer and red LEDs for alarm signaling whenever exposures exceed preset limits
- Charge contacts for plugging directly to its charging station
- Gas entry and exit ports
- USB communication port for PC interface
- Protective rubber cover

Easy-to-use separation tube holder (UltraRAE 3000+)

3

CHARGING THE BATTERY

Always fully charge the battery before using the instrument. The instrument's Li-ion battery is charged by attaching the instrument to the Travel Charger (or by placing the instrument in the optional Charging cradle). Contacts on the bottom of the instrument meet the Travel Charger's (or Charging cradle's) contacts, transferring power without other connections.

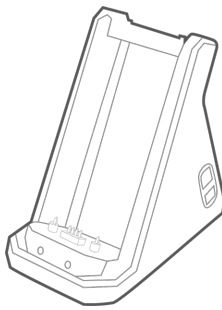

Charging cradle

PN: 059-3059-000

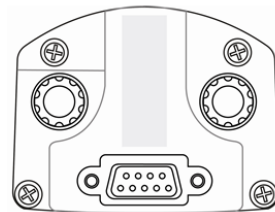
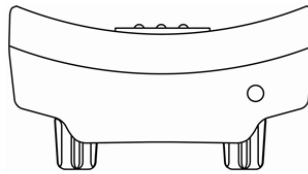

Travel charger

PN: 059-3014-000

Note: Before connecting the charger to the instrument, visually inspect the contacts to make sure they are clean. If they are not, wipe them with a soft cloth. Do not use solvents or cleaners.

Follow this procedure to charge the instrument:

1. Plug the AC/DC adapter's barrel connector into the instrument's Charging cradle or Travel Charger.

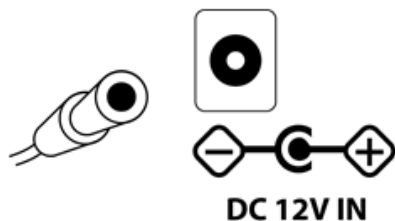

2. Plug the AC/DC adapter into the wall outlet.
3. Connect the AC/DC adapter to the Travel Charger (or Charging cradle).
4. Place the instrument into the Travel Charger or Charging cradle. The LED in the Travel Charger (or Charging cradle) should glow.

The instrument begins charging automatically. (If the optional Charging cradle is used, the “Primary” LED blinks green to indicate charging.) During charging, the diagonal lines in the battery icon on the instrument’s display are animated and you see the message “Charging...”



Note: If the Li-ion battery has been discharged below a certain threshold, the “Charging...” message does not display immediately. The charging LED blinks to indicate that it is charging, and after it has been charging for a while, the “Charging...” message appears.

When the instrument’s battery is fully charged, the battery icon is no longer animated and shows a full battery. The message “Fully charged!” is shown. (If the Charging cradle or Travel Charger is used, its LED glows continuously green.)

Note: If you see the “Battery Charging Error” icon (a battery outline with an exclamation mark inside), check that the instrument or rechargeable battery has been properly set into the Travel Charger (or Charging cradle). If you still receive the message, check the Troubleshooting section of this guide.



Note: If the instrument or battery has been charging for more than 10 hours and you see the “Battery Charging Error” icon and a message that says, “Charging Too Long,” this indicates that the battery is not reaching a full charge. Try changing the battery and make sure the contacts on the instrument are meeting the Travel Charger’s (or Charging cradle’s) contacts. If the message is still shown, consult your distributor or Honeywell Technical Services.

 **WARNING**

To reduce the risk of ignition of hazardous atmospheres, recharge and replace batteries only in areas known to be non-hazardous. Remove and replace batteries only in areas known to be non-hazardous.

Notes: A rechargeable intrinsically safe Li-ion battery (059-3051-000) for use with MiniRAE3000+ / ppbRAE3000+ / UltraRAE3000+, a rechargeable Lithium-ion battery (059-3053-000) (NOT intrinsically safe) for MiniRAE Lite+ only, and an Alkaline battery pack (059-3052-000) can be charged by placing it directly in the charging port on the back of the Charging cradle. It can be charged at the same time as the instrument. Press the battery in place, sliding it slightly toward the front of the Charging cradle. This locks it in the Charging cradle. To release the battery, slide it forward again and tilt it up.

Note: An Alkaline Battery Adapter (part number 059-3052-000), which uses four AA alkaline batteries (Duracell MN1500), may be substituted for the Li-Ion battery.

Charging a spare rechargeable battery

A rechargeable Li-ion battery can be charged when it is not inside the monitor. The Charging cradle is designed to accommodate both types of charging. Contacts on the bottom of the battery meet the contacts on the Charging cradle, transferring power without other connections, and a spring-loaded capture holds the battery in place during charging.

1. Plug the AC/DC adapter into the monitor's Charging cradle.
2. Place the battery into the Charging cradle, with the gold-plated contacts on top of the six matching charging pins.
3. Plug the AC/DC adapter into the wall outlet.

The battery begins charging automatically. During charging, the Secondary LED in the Charging cradle blinks green. When charging is complete, it glows steady green.

Release the battery from the Charging cradle by pulling it back toward the rear of the Charging cradle and tilting it out of its slot.

Note: If you need to replace the Li-ion battery pack, replacements are available from Honeywell. The part number is 059-3051-000.

Note: An Alkaline Battery Adapter (part number 059-3052-000), which uses four AA alkaline batteries (Duracell MN1500), may be substituted for the Li-Ion battery.



WARNING

To reduce the risk of ignition of hazardous atmospheres, recharge and replace batteries only in areas known to be non-hazardous. Remove and replace batteries only in areas known to be non-hazardous.

Replacing rechargeable Li-Ion battery



CAUTION

Turn off the instrument before removing or replacing the battery.

Low voltage warning

When the battery's charge falls below a preset voltage, the instrument warns you by beeping once and flashing once every minute, and the "empty battery" icon blinks on and off once per second. You should turn off the instrument within 10 minutes and either recharge the battery by placing the instrument in its Charging cradle, or replace the battery with a fresh one with a full charge.



Clock battery

An internal clock battery is mounted on one of the instrument's printed circuit boards. This long-life battery keeps settings in memory from being lost whenever the Li-ion battery or alkaline batteries are removed. This backup battery should last approximately five years and must be replaced by an authorized Honeywell service technician. It is not user-replaceable.



WARNING

To reduce the risk of ignition of hazardous atmospheres, recharge battery only in area known to be non-hazardous. Remove and replace battery only in an area known to be non-hazardous.

Data protection while power is off

When the instrument is turned off, all the current real-time data including last measured values are erased. However, the datalog data is preserved in non-volatile memory. Even if the battery is disconnected, the datalog data will not be lost.

Alkaline battery pack

An alkaline battery pack is supplied with each instrument. The pack (part number 059-3052-000) accepts four AA alkaline batteries (use only Duracell MN1500).

Do not mix old and new batteries or different type batteries.

Turning the instrument on

1. With the instrument turned off, press and hold [MODE].
2. When the display turns on, release the [MODE] key.

The instrument is now operating and performs self-tests. Once the self-tests are complete, the display shows a graph or numerical gas reading. This indicates that the instrument is fully functional and ready to use.

Turning the instrument off

1. Press and hold the [MODE] key for 3 seconds. A 5-second countdown to shutoff begins.
2. Once the countdown stops, the instrument is off. Release the [MODE] key.
3. When you see “Unit off...” release your finger from the [MODE] key. The instrument is now off.

Note: You must hold your finger on the key for the entire shutoff process. If you remove your finger from the key during the countdown, the shutoff operation is canceled and the instrument continues normal operation.

USER INTERFACE

The instrument's user interface consists of the display, LEDs, an alarm transducer, and four keys.

The keys are:

- Y/+
- MODE
- N/-
- Flashlight on/off

The LCD display provides visual feedback that includes the reading, time, battery condition, and other functions.

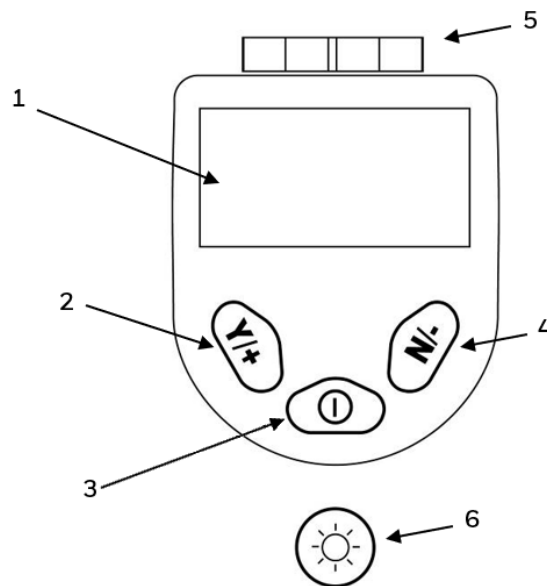

No.	Item	No.	Item
1	Display	4	N/- key
2	Y/+ key	5	LEDs and flashlight
3	MODE key	6	Flashlight on/off key

In addition to their labeled functions, the keys labeled Y/+, MODE, and N/- act as “soft keys” that control different parameters and make different selections within the instrument's menus. From menu to menu, each key controls a different parameter or makes a different selection.

Three panes along the bottom of the display are “mapped” to the keys. These change as menus change, but at all times the left pane corresponds to the [Y/+]
 key, the center pane corresponds to the [MODE] key, and the right pane corresponds to the [N/-]
 key. Here are three examples of different menus with the relationships of the keys clearly shown:

MiniRAE 3000+, ppbRAE 3000+, UltraRAE 3000+

Relationship of buttons to control functions

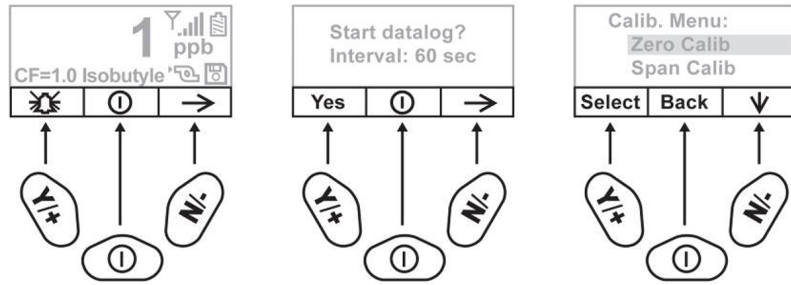

MiniRAE Lite+

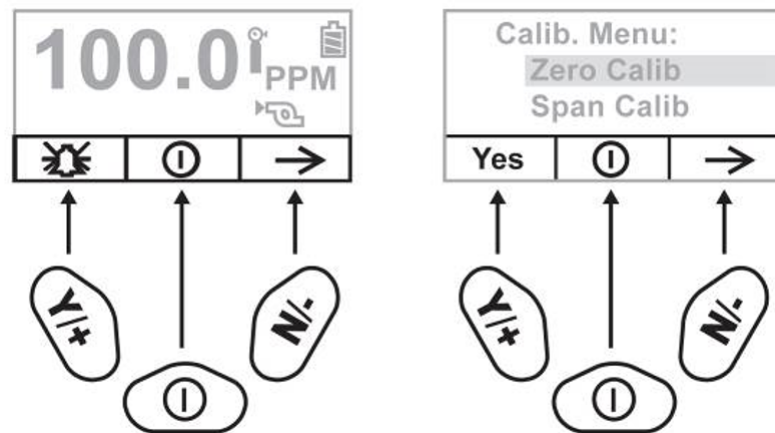

Display

The display shows the following information:

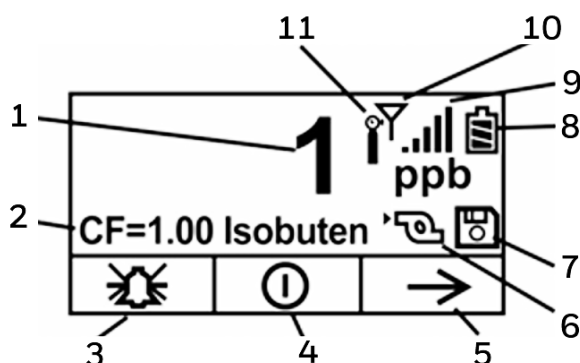

NO.	Item	Description
1	Reading	Concentration of gas as measured by the instrument
2	Gas info	Tells the Correction Factor and type of calibration gas
3	Y/+ key	Y/+ key's function for this screen
4	MODE key	MODE key's function for this screen
5	N/- key	N/- key's function for this screen
6	Pump	Indicates that pump is working
7	Datalog	Indicates whether datalog is on or off
8	Battery	Indicates level in 3 bars
9	Radio signal	Indicates signal strength (more bars = greater strength)
10	Radio power	Indicates whether Mesh radio connection is on or off
11	Calibration needed	Indicates that calibration should be performed
	Calibration (or bump) needed (not shown)	Dark icon indicates that calibration should be performed; light icon indicates bump should be performed
	LoRa connectivity icon (not shown)	LoRa connectivity icon (T ²) when available in the instrument

Note:The “Radio power” icon and “Radio signal” icon are only shown if a Mesh radio is installed in the instrument. If the instrument has a BLE radio, the Bluetooth icons shown on the next page are used.



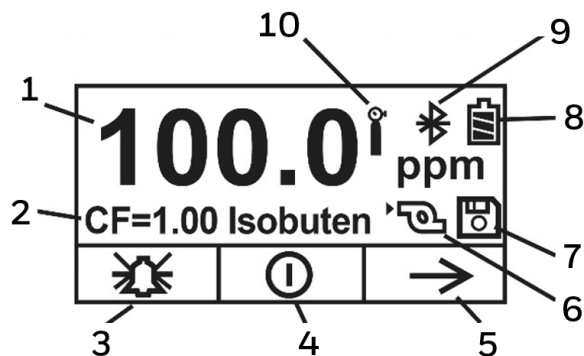







If the instrument is equipped with BLE instead of other wireless, the BLE Status icon is shown:



No.	Item
1	Reading
2	Gas info
3	Y/+ key
4	MODE key
5	N/- key
6	Pump
7	Datalog
8	Battery
9	BLE status
10	Calibration or bump needed

Icons

These are the icons shown on the display to indicate functions or status.

	The instrument has been bump tested and calibrated in compliance with the policy settings.
	Battery level
	Charging error
	Calibration required
	Bump test required
	Datalog on
	Radio Power (Bluetooth or Mesh)
	Radio signal
	Pump operational
	Pump blocked or stalled
	BLE status: Installed, Connected, Turned off

6

OPERATING THE INSTRUMENT

The instrument is designed as a broadband VOC gas monitor and datalogger for work in hazardous environments. It gives real-time measurements and activates alarm signals whenever the exposure exceeds preset limits. Prior to factory shipment, the instrument is preset with default alarm limits and the sensor is pre-calibrated with standard calibration gas. However, you should test the instrument and verify the calibration before the first use. After the instrument is fully charged and calibrated, it is ready for immediate operation.

Turning the instrument on

1. With the instrument turned off, press and hold [MODE].
2. When the display turns on, release the [MODE] key.



Note: The main display may show ppb or ppm and other features, depending on the instrument. The Honeywell logo should appear first. (If the logo does not appear, there is likely a problem and you should contact your distributor or Honeywell RAE Systems Technical Support.) The instrument is now operating and performs self-tests. If any tests (including sensor and memory tests fail), refer to the Troubleshooting section of this guide.

Once the startup procedure is complete, the instrument shows a numerical reading screen with icons. This indicates that the instrument is fully functional and ready to use.

Turning the instrument off

1. Press and hold the [MODE] key for 3 seconds. A 5-second countdown to shutoff begins.
2. Once the countdown stops, the instrument is off. Release the [MODE] key.
3. When you see “Unit off...” release your finger from the [MODE] key. The instrument is now off.

Note: You must hold your finger on the key for the entire shutoff process. If you remove your finger from the key during the countdown, the shutoff operation is canceled and the instrument continues normal operation.

Auto-zero at startup

Using Honeywell Safety Suite Device Configurator (SSDC), the instrument can be programmed to automatically perform a zero calibration after self-testing during startup.

Note: The option is disabled by default. If it is disabled, the instrument performs its self-test and then goes directly to reading mode.

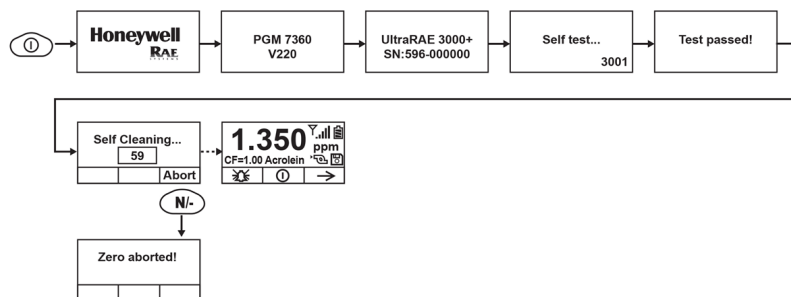

The zeroing process can be aborted by pressing the [N/-] key at any time during the process, and the instrument will go directly to normal reading mode.

Notes:

- When a ppbRAE 3000+ is in normal reading mode and is not in system alarm (Low Alarm or High Alarm), zero calibration is triggered in a locked interval (1 hour). If the instrument is in low alarm, Auto Zero is skipped until the alarm clears.
- We do not recommend using this function on the UltraRAE3000+ and ppbRAE3000+.
- We highly recommend that you make sure the instrument is in a clean air environment during startup and zeroing.
- After firmware version v2.20, the instrument performs a Reflex PID Technology process followed by fresh air calibration process.

Operating the built-in flashlight

The instrument has a built-in flashlight that helps you point the probe in dark places. Press the flashlight key to turn it on. Press it again to turn it off.



Note: Using the flashlight for extended periods shortens the battery's operating time before it needs recharging.

Pump status

IMPORTANT!

During operation, make sure the probe inlet and the gas outlet are free of obstructions. Obstructions can cause premature wear on the pump, false readings, or pump stalling. During normal operation, the pump icon alternately shows inflow and outflow as shown here:



During duty cycling (PID lamp cleaning), the display shows these icons in alternation:



If there is a pump failure or obstruction that disrupts the pump, you will see this icon blinking on and off:



If you see this blinking icon, consult the Troubleshooting section of this guide.

Calibration status

The instrument displays this icon if it requires calibration:

Calibration is required (and indicated by this icon) if:



- The lamp type has been changed (for example, from 10.6 eV to 9.8 eV).
- The sensor has been replaced.
- It has been 30 days or more since the instrument was last calibrated.
- If you have changed the calibration gas type without recalibrating the instrument.
- If the instrument fails a bump test.

Bump status

Note: The sensor(s) should be challenged on a periodic basis.

The instrument displays this icon if it requires a bump test:



A bump test is required (and indicated by this icon) if:

- The defined period between bump tests has been exceeded (bump test overdue).
- The sensor has failed a previous bump test.

Glance mode

Glance Mode allows you to get vital information without turning on the instrument. You can check information such as the instrument’s model and serial number, installed sensor types, wireless modules installed, etc., which may help when taking inventory of instruments and their sensors or when working with service or support personnel. Glance Mode can be enabled/disabled via Honeywell Safety Suite Device Configurator (SSDC).

Enter glance mode

Note: The instrument must be configured so that Glance Mode is turned on (the default mode is “Off”). This can be done in Safety Suite Device Configurator (SSDC). In SSDC, Glance Mode can be enabled or disabled by checking or unchecking the box labeled “Enable Glance Mode.” You can also set which screens will be displayed, as well as their order.

With the instrument turned off, press and hold [MODE] and [N/-] simultaneously for 2 seconds to enter Glance Mode. If you see the message “GLANCE MODE DISABLED,” you must configure the instrument to use Glance Mode.

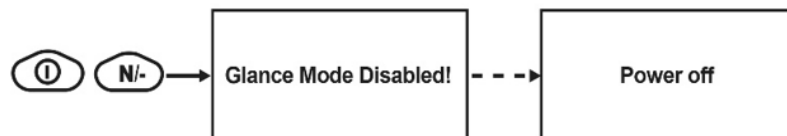

If Glance Mode is enabled, the first screen, with the Honeywell Logo, is displayed. Release the [MODE] and [N/-] keys, and the first screen with information about the instrument is shown.

Note: If there is no information to show, the instrument will display “No Screen Display!” and turn itself off.

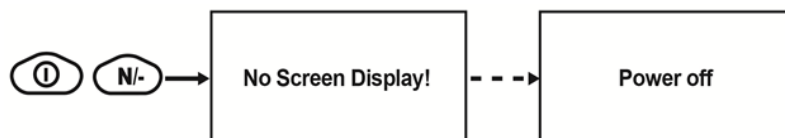

Glance mode screens

Every screen displayed in sequence as configuration. Press [N/-] to advance to the next screen. If the Wireless modem is turned off, the screen shows “Disabled”. Otherwise, the type of wireless is shown. When the last screen is shown, pressing [N/-] “loops” to the first screen.

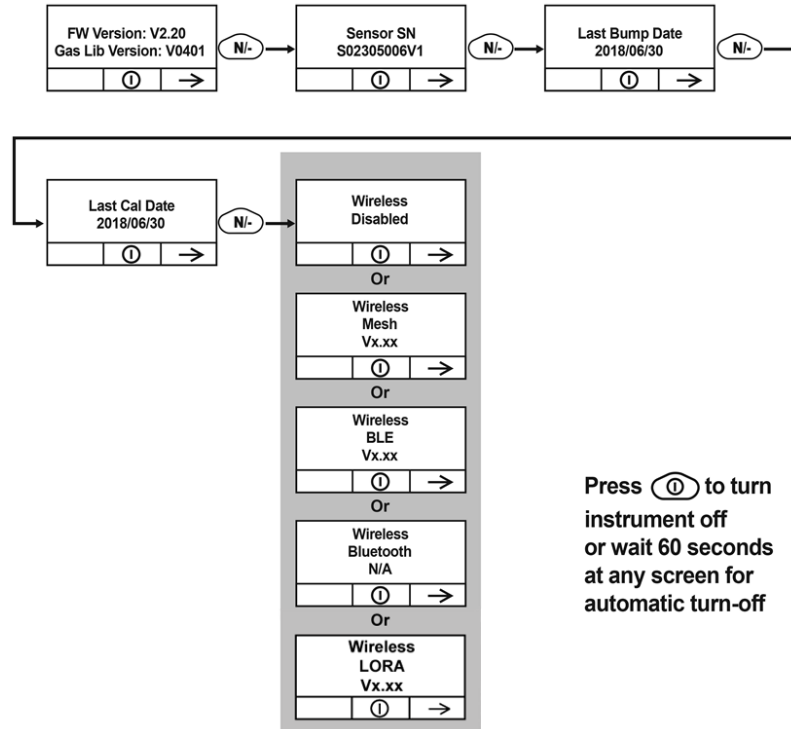

Exit glance mode

The instrument exits Glance Mode and turns off when you press the [MODE] key. The display shows “Power Off”, and after 3 seconds, it turns off. In addition, if you do not press either key in 60 seconds, the instrument automatically exits Glance Mode and shuts off.

Reverse direction navigation

Sometimes you want to go back to a previous screen rather than advance through an entire set of screens before “wrapping around” to that screen again.

To reverse direction:

1. Press and hold [N/-] for 3 seconds.
2. When the arrow changes from pointing up to pointing down, release your finger.

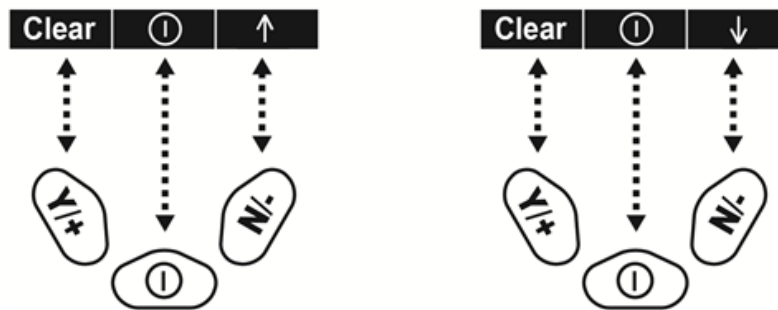

Now when you press [N/-], you step back through the screens.

To change direction again: Press and hold [N/-] for 3 seconds and then release.

Note: Changing direction does not work with all screens. It works primarily in submenus.

Policy enforcement

The instrument can be configured to enforce a facility/company’s requirements that calibration and/or bump testing be performed at specified intervals, and to explicitly prompt the user that calibration/bump testing is required. Depending on how Policy Enforcement features are configured, the user may be required to perform a bump test or calibration prior to being able to use the instrument. That is, it can be set to not allow normal operation of the instrument unless calibration or bump testing is performed and passed.

If the instrument has been bump tested and calibrated in compliance with the policy settings, a check-mark icon is included along the top of the instrument’s screen:



If Policy Enforcement is enabled, then after startup the instrument displays a screen that informs the user that the instrument requires either a bump test or a calibration. If both are required, then they are shown in sequence.

Note: Policy enforcement features are disabled by default.

Setting policy enforcement

You must use Safety Suite Device Configurator (SSDC) to make changes to Policy Enforcement settings. You must use an AutoRAE 2 Cradle, a Travel Charger, or a Charging cradle. Policy violations are captured in the datalog.

Using the travel charger, Charging cradle, or AutoRAE 2 automatic test and calibration system

To program an instrument via an AutoRAE 2, you need Safety Suite Device Configurator (SSDC), the AutoRAE 2 connected to a power source, and a USB PC communications cable.

1. Connect a USB cable between a PC with Safety Suite Device Configurator (SSDC) and the AutoRAE 2 Cradle, Travel Charger, or Charging cradle.
2. Apply power to the AutoRAE 2 Cradle, Travel Charger, or Charging cradle.
3. Turn off the instrument (or put it into AutoRAE 2 Mode or Communication Mode) and set it in the Charging cradle.
4. Start Safety Suite Device Configurator (SSDC) software on the PC. Enter a username and password (the default administrator username is “administrator” and the password is “Default123”).
5. The software will scan automatically for instruments.

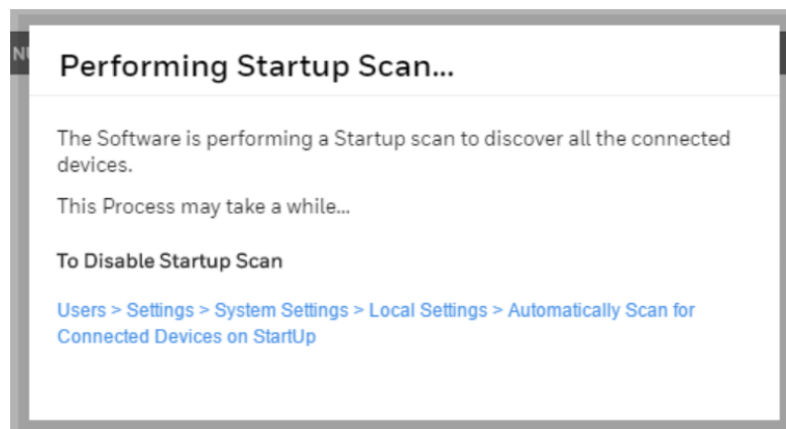

6. The list of instruments will appear in the main screen along with their serial number. In SSDC, the devices are shown, including their Serial Number, with the “Connected” icon:



- Click on the serial number of the device to open its characteristics.

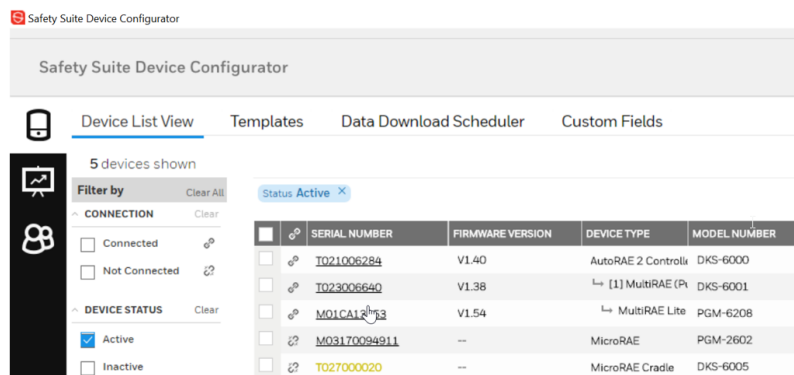

- Click on “Settings” and scroll down to “Policy Settings”

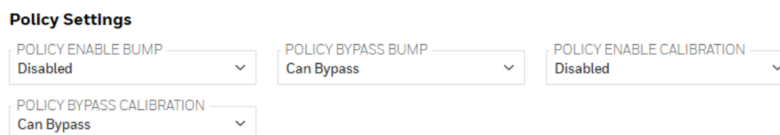

- Policy Enable Bump” and “Policy Enable Calibration” can be enabled or disabled from this screen. “Policy Bypass Bump” and “Policy Bypass Calibration” can also be activated or deactivated from this screen.

Must Calibrate. The user is prompted to calibrate the instrument when calibration is due (as set by the calibration interval). There are two programmable options:

- **Can’t Bypass.** Unless calibration is performed and passed, the instrument cannot be used, and the only option is to turn off the instrument.
- **Can Bypass.** If calibration is due but the user does not want to perform a calibration, the instrument can still be used. In this case, the instrument records that the user has bypassed the calibration requirement in a Policy Violation report.

Must Bump. The user is prompted to bump test the instrument when a bump test is due (as set by the bump test interval). There are two programmable options:

- **Can’t Bypass.** Unless a bump test is performed and passed, the instrument cannot be used, and the only option is to turn off the instrument.
- **Can Bypass.** If a bump test is due but the user does not want to perform one, the instrument can still be used. In this case, the instrument records that the user has bypassed the bump testing requirement in a Policy Violation report.

These are the screens that are shown on the instrument after startup if “Can Bypass” is selected:

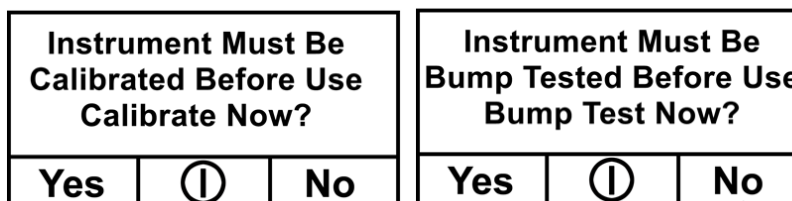

If “Can’t Bypass” is selected, the display looks like this, and only allows the options of performing the test or shutting down:

Instrument Must Be Calibrated Before Use Calibrate Now?			Instrument Must Be Bump Tested Before Use Bump Test Now?		
Yes	ⓘ		Yes	ⓘ	

10. Once you have made your selections in Safety Suite Device Configurator (SSDC), you must

upload the changes to the instrument. Click on  and the changes will be applied to the equipment.”

- 11. Exit Safety Suite Device Configurator (SSDC).
- 12. Press [Y/+] on the instrument to exit Communication Mode.

OPERATING MODES

MiniRAE 3000+ & ppbRAE 3000+

Your instrument operates in different modes, depending on the model and its factory default settings. In some cases, you can change modes using a password and the instrument's navigation. In other cases, you must use Safety Suite Device Configurator (SSDC) software.

The default setting for your instrument is:

User Level: Basic

Operation Mode: Hygiene

This is outlined in detail on See "Basic user level/hygiene mode" on the next page for more information.

The other options, covered later in this guide, are:

User Level: Advanced (page 74)

Operation Mode: Hygiene

User Level: Advanced (page 74)

Operation Mode: Search

Using Safety Suite Device Configurator (SSDC) allows access to other options. In addition, Diagnostic Mode (See "Diagnostic mode" on page 98 for more information.) is available for service technicians.

Basic user level/hygiene mode

Default Settings – MiniRAE 3000+ & ppbRAE 3000+

The instrument is programmed to operate in Basic User Level/Hygiene Mode as its default. This gives you the most commonly needed features while requiring the fewest parameter adjustments.

Pressing [N/-] steps you from one screen to the next, and eventually return to the main display. If you do not press a key within 60 seconds after entering a display, the instrument reverts to its main display.

Note: While viewing any of these screens, you can shut off your instrument by pressing [MODE].

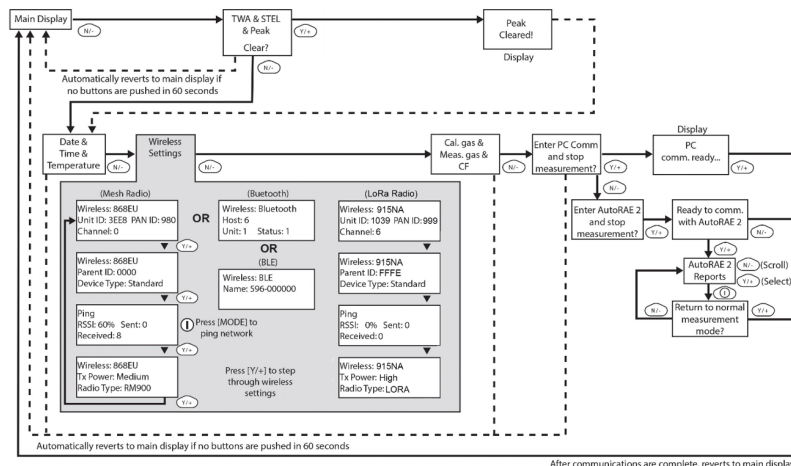

Note: At the Average & Peak, Date & Time & Temperature, Calibration Gas & Measurement Gas & Correction Factor, and PC Communications screens, the instrument automatically goes to the main display after 60 seconds if you do not push a key to make a selection.

UltraRAE 3000+

The UltraRAE is actually two monitors in one:

- Compound-specific monitor
- VOC monitor

As a compound-specific monitor, it takes timed measurements and uses a separation tube in conjunction with software that enables the UltraRAE 3000+ to give specific readings on one particular type of compound, such as benzene or butadiene.

As a VOC monitor, the UltraRAE 3000+ operates in different modes. In some cases, you can change modes using a password and using the instrument's navigation. In other cases, you must use Safety Suite Device Configurator (SSDC) software.

The following two sections cover operation in the two modes.

- See "UltraRAE 3000+ operation" on page 40 for more information.
- See "VOC operation - UltraRAE3000+" on page 47 for more information.

The next diagram shows the basic flow of the UltraRAE 3000+'s functions. The area with the gray field is the compound-specific (tube) mode, while the rest shows VOC mode. Navigate through the steps by using the [Y/+] and [N/-] keys as shown in the diagram.

Note: If you use a password to access Programming Mode (See "Programming mode" on page 68 for more information.), then the navigation changes slightly, entering part of Advanced Hygiene Mode's settings (See "Advanced user level" on page 95 for more information.).

Compound-Specific (Tube)

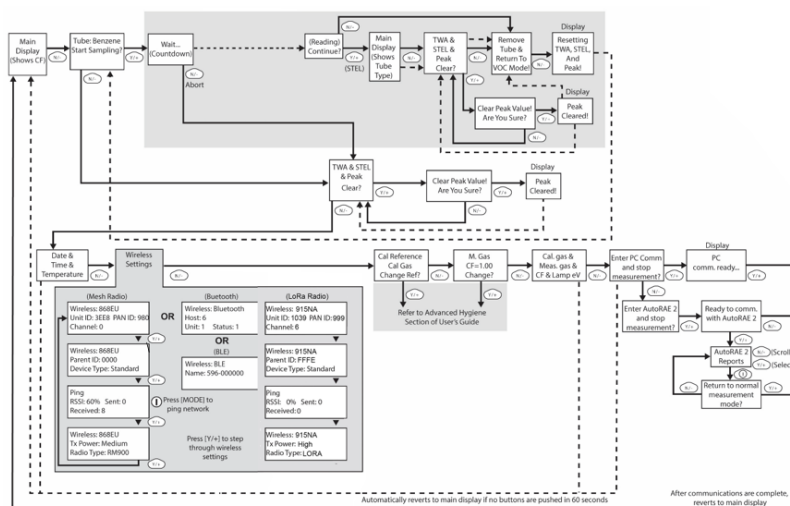

Note: Dashed line indicates automatic progression.

The default setting for your instrument is:

User Level: Basic

Operation Mode: Hygiene

See "Hygiene mode" on page 93 for more information..

The other options, covered later in this guide, are:

User Level: Advanced (See "Advanced user level" on page 95 for more information.)

Operation Mode: Hygiene

User Level: Advanced (See "Advanced user level" on page 95 for more information.)

Operation Mode: Search

Using Safety Suite Device Configurator (SSDC) allows access to other options. In addition, Diagnostic Mode (See "Diagnostic mode" on page 98 for more information.) is available for service technicians.

8

ULTRARAE 3000+ OPERATION

Compound-specific measurement

The UltraRAE 3000+ can perform compound-specific measurement in addition to general VOC measurement. This requires using a RAE-Sep separation tube (butadiene or benzene) and having the UltraRAE 3000+ in Tube Mode, operating with a 9.8eV lamp.

Measurement phases

To perform a compound-specific measurement, follow this order:

1. UltraRAE 3000+ is ready for sampling
2. Prepare the separation tube
3. Insert the separation tube
4. Start measurement
5. UltraRAE 3000+ displays and logs measurement
6. Remove the separation tube

Performing a measurement

Before performing a compound-specific measurement for Benzene or Butadiene using a RAE-Sep™ separation tube, make sure the UltraRAE 3000+ is in Tube Mode and that the appropriate tube type is selected. The UltraRAE 3000+ only acts as a compound-specific measurement device when it is equipped with a 9.8eV lamp. The user must select the lamp type and it can be manually set to default to a 9.8eV lamp type.

Make sure the UltraRAE 3000+ is set to operate with your selected tube:

1. Enter Programming Mode.
2. Select Measurement.
3. Select Tube Selection.
4. Make a choice of Benzene or Butadiene.
5. Save your choice.

To begin measuring, turn on the UltraRAE 3000+. This screen is shown, which includes the CF (correction factor) and measurement gas type for calibration reference:



Press [N/-] to advance. You will see this screen:

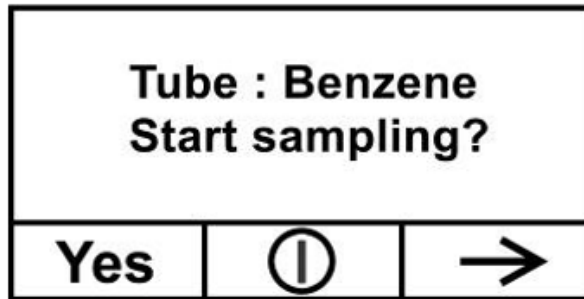

WARNING

Do not begin sampling yet! Before you start sampling, you must insert a RAE-Sep separation tube into the inlet/holder. Follow the Separation tube preparation and placing a tube into the UltraRAE 3000+ instructions before pressing any buttons on the UltraRAE 3000+. Once the tube is in place, then proceed to measuring.

IMPORTANT!

Once a tube's ends are broken off, the material inside is exposed. Therefore, use the tube for sampling as soon as possible. It is recommended to use within 15 minutes.

Separation tube preparation



CAUTION

Wear hand and eye protection when breaking tube tips. Use caution in handling tubes with broken ends. Keep away from children. RAE-Sep tubes should be disposed of according to local regulations. See footnotes of data sheets for disposal information.

Only use Honeywell RAE Systems tubes.

Handle tubes with care. Tube ends are sharp after ends are broken off.

1. Open a package of RAE-Sep separation tubes and remove one.
2. Place the tip in the package's tube tip breaker (the small hole on the front) and snap off the tip.
3. Turn the tube around and snap off the other end.

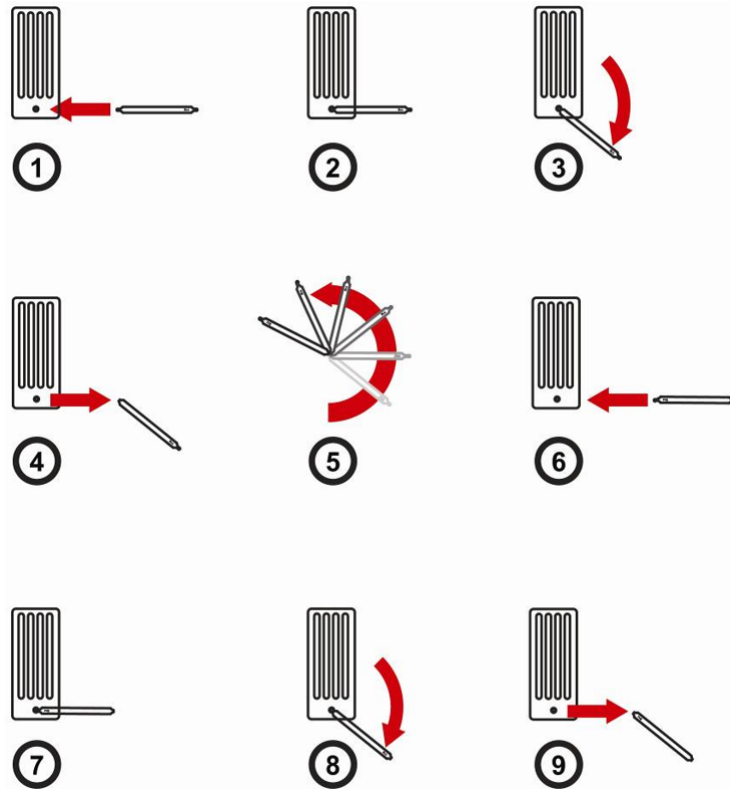

Inserting the separation tube

1. Unscrew the front of the sampling probe from the base.
2. Slip the tube into the rubber holder in the front portion. Make sure the arrow on the side of the tube points toward the instrument.

Insert the other end of the tube into the middle of the base while turning the front portion to tighten it onto the base's threads.

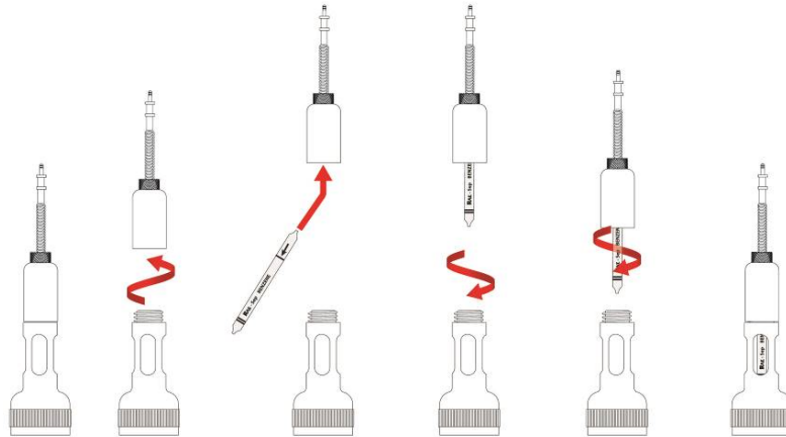

Note: When the UltraRAE 3000+ is used for VOC monitoring, no tube is inserted.

IMPORTANT!

Do not overtighten any portion of the sampling assembly.

To ensure that there are no leaks, periodically test the seals:

With the UltraRAE 3000+ running, place your finger over the end of the inlet probe. The alarm should sound and the pump-stall icon should flash on the display. This indicates that all seals are good. Stop the alarm by pressing [Y/+]. If the pump does not alarm or show the stalled-pump icon, then check that all inlet parts are tight and inspect the O-ring for damage (replace it if necessary).

Measuring

Once the tube is in place, begin measuring by pressing [Y/+].

The display shows a countdown (60 seconds is shown here, but sampling time depends on the type of separation tube selected and the temperature):

Wait ... 60		
		Abort

Note: You can abort the sampling by pressing [N/-] at any time.

Once the countdown is complete, the reading is shown:

Benzene= 0.00 ppm Continue and establish STEL?		
Yes		No

Press [Y/+] to continue sampling with the tube for 15 minutes to establish a STEL reading, or press [N/-] to return to the main menu.



WARNING

At least 1/4 of the tube should still be yellow-orange at the bottom. If not, the STEL value is not valid. Abort the measurement and change the tube. Then do a snapshot test instead of a STEL test. Note: If the STEL is exceeded, the UltraRAE 3000+ goes into alarm.

If you press [N/-] to return to the main menu, which shows the tube type instead of the CF (correction factor):

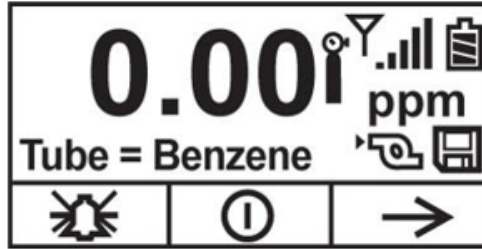

Press [N/-] to advance to this screen:

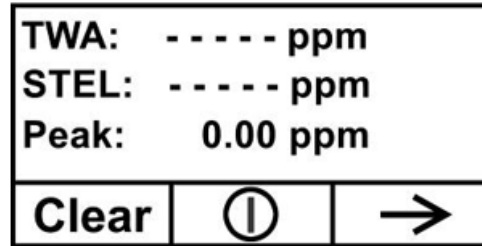

If you press [Y/+], you are asked, "Clear peak value! Are You Sure?" to confirm:

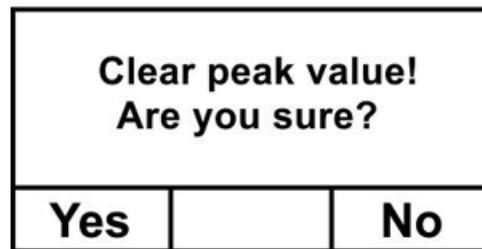

Press [Y/+] to clear the Peak value and exit to VOC operation.

If you press [N/-], this display is shown:

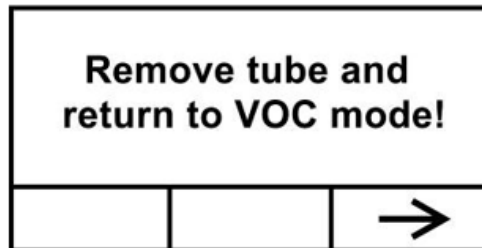

Remove the tube and put the inlet back together. Then press [N/-]. This display is shown:

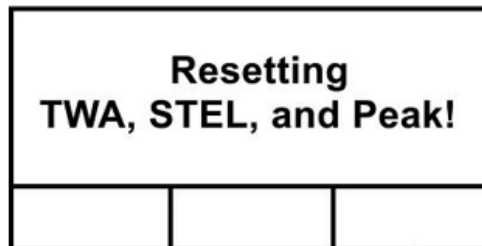

After a few seconds, the UltraRAE 3000+ enters VOC mode and shows this display:

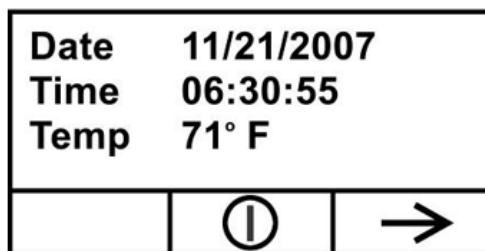

You can step through the rest of the steps by pressing [N/-] repeatedly until you reach the main menu again.

Basic user level/hygiene mode (Default settings)

The instrument is programmed to operate in Basic User Level/Hygiene Mode as its default. This gives you the most commonly needed features while requiring the fewest parameter adjustments.

Pressing [N/-] steps you from one screen to the next, and eventually return to the main display. If you do not press a key within 60 seconds after entering a display, the instrument reverts to its main display.

Note: While viewing any of these screens, you can shut off your instrument by pressing [MODE].

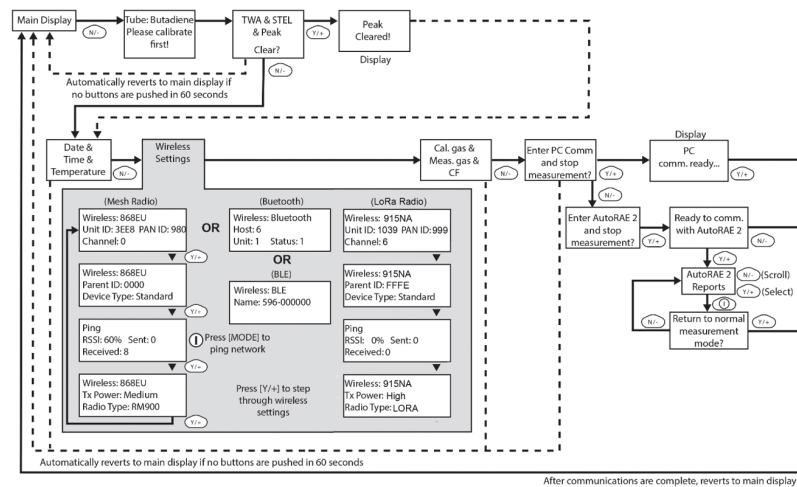

Note: Dashed line indicates automatic progression.

Note: At the Average & Peak, Date & Time & Temperature, Calibration Gas & Measurement Gas & Correction Factor, and PC Communications screens, the instrument automatically goes to the main display after 60 seconds if you do not push a key to make a selection.

Basic operation – MiniRAE 3000+

The instrument is programmed to give you the most commonly needed information quickly.

Pressing [N/-] steps you from one screen to the next, and eventually return to the main display. If you do not press a key within 60 seconds after entering a display, the instrument reverts to its main display.

Note: While viewing any of these screens, you can shut off your instrument by pressing [MODE].

Note: At the Average & Peak, Date & Time & Temperature, Calibration Gas & Measurement Gas & Correction Factor, and PC Communications screens, the instrument automatically goes to the main display after 60 seconds if you do not push a key to make a selection.

10 ALARM SIGNALS

During each measurement period, the gas concentration is compared with the programmed alarm limits (gas concentration alarm limit settings). If the concentration exceeds any of the preset limits, the loud buzzer and red flashing LED are activated immediately to warn you of the alarm condition. In addition, the instrument alarms if one of the following conditions occurs: battery voltage falls below a preset voltage level, failure of the UV lamp, pump stall, or when the datalog memory is full.

Alarm signal summary

Message	Condition	Alarm Signal
HIGH	Gas exceeds "High Alarm" limit	3 beeps/flashes per second*
OVR	Gas exceeds measurement range	3 beeps/flashes per second*
MAX	Gas exceeds electronics' maximum range	3 beeps/flashes per second*
LOW	Gas exceeds "Low Alarm" limit	2 beeps/flashes per second*
TWA	Gas exceeds "TWA" limit	1 Beep/flash per second*
STEL	Gas exceeds "STEL" limit	1 Beep/flash per second*
Pump icon flashes	Pump failure	3 beeps/flashes per second
Lamp	PID lamp failure	3 beeps/flashes per second plus "Lamp" message on display
Battery icon flashes	Low battery	1 flash, 1 beep per minute plus battery icon flashes on display
CAL	Calibration failed, or needs calibration	1 beep/flash per second
NEG	Gas reading measures less than number stored in calibration	1 beep/flash per second

* MiniRAE 3000+, ppbRAE 3000+, and UltraRAE 3000+: Hygiene mode only. In Search mode, the number of beeps per second (1 to 7) depends upon the concentration of the sampled gas. Faster rates indicate higher concentrations.

Preset alarm limits & calibration

The instrument is factory calibrated with standard calibration gas and is programmed with default alarm limits. These settings can be changed in Programming Mode to align more precisely with your standards.

MiniRAE Lite+

Cal Gas (Isobutylene)	Cal Span	Unit	Low	High
MiniRAE Lite+	100	ppm	50	100

MiniRAE 3000+

Cal Gas (Isobutylene)	Cal Span	Unit	Low	High	TWA	STEL
MiniRAE 3000+	100	ppm	50	100	10	25

ppbRAE 3000+

Cal Gas (Isobutylene)	Cal Span	Unit	Low	High	TWA	STEL
ppbRAE 3000+	10	ppm	10	25	10	25

UltraRAE 3000+

Cal Gas	Cal Span	Unit	Low	High	TWA	STEL
Isobutylene	100	ppm	50	100	10	25
Benzene	5	ppm	2	5	0.5	2.5
Butadiene	10	ppm	5	10	2	5

Testing the alarm

You can test the alarm whenever the main (Reading) display is shown. Press [Y/+], and the audible and visible alarms are tested.

Integrated sampling pump

The instrument includes an integrated sampling pump. This diaphragm-type pump that provides a 450 to 550 cc per minute flow rate. Connecting a Teflon or metal tubing with 1/8" inside diameter to the gas inlet port of the instrument, this pump can pull in air samples from 100' (30 m) horizontally or vertically.

Note: In Search Mode, the pump turns on when a sample measurement is started, and turns off when the sample is manually stopped.

If liquid or other objects are pulled into the inlet port filter, the instrument detects the obstruction and immediately shuts down the pump. The alarm is activated and a flashing pump icon is displayed. You should acknowledge the pump shutoff condition by clearing the obstruction and pressing the [Y/+] key while in the main reading display to restart the pump.

Backlight

The LCD display is equipped with an LED backlight to assist in reading the display under poor lighting conditions.

Datalogging

During datalogging, the instrument displays a disk icon to indicate that datalogging is enabled. The instrument stores the measured gas concentration at the end of every sample period (when data logging is enabled). In addition, the following information is stored: user ID, site ID, serial number, last calibration date, and alarm limits. All data are retained (even after the unit is turned off) in non-volatile memory so that it can be downloaded later to a PC.

Datalogging event

When Datalogging is enabled, measurement readings are being saved. These data are stored in "groups" or "events." A new event is created and stored each time the instrument is turned on and is set to automatic datalogging, or a configuration parameter is changed, or datalogging is interrupted. The maximum time for one event is 24 hours or 28,800 points. If an event exceeds 24 hours, a new event is automatically created. Information, such as start time, user ID, site ID, gas name, serial number, last calibration date, and alarm limits are recorded.

Datalogging sample

After an event is recorded, the unit records a shorter form of the data. When transferred to a PC running Safety Suite Device Configurator (SSDC), this data is arranged with a sample number, time, date, gas concentration, and other related information.

Auto/manual/snapshot datalogging

The instrument has three datalog types:

- Auto** Default mode. Collects datalog information when the instrument is sampling.
- Manual** Datalogging occurs only when the instrument's datalogging is manually started (See "Manual datalog" on page 84 for more information.)
- Snapshot** Datalogs only during snapshot (single-event capture, initiated by pressing [MODE]) sampling. See "Snapshot datalog" on page 84 for more information.

Note: You can only choose one datalog type to be active at a time.

Accessories

MiniRAE Lite+

The following accessories are included with the instrument:

- 10.6 eV lamp
- Flex-I-Probe
- External filter
- Green rubber boot
- Alkaline battery adapter
- Lamp cleaning kit
- Tool Kit
- Lithium-Ion (Li-Ion) battery, if specified
- Travel Charger, if specified
- Universal wall adapter, if specified
- Quick Reference Guide
- Soft leather carrying case

MiniRAE 3000+ & ppbRAE 3000+

Includes same accessories as MiniRAE Lite+ plus the following accessories:

- AC Adapter (Battery Charger)
- Alkaline battery adapter
- External Filter

Hard-case kits also include these accessories:

- Calibration adapter
- Calibration regulator and Flow controller

UltraRAE 3000+

Note: These include the tube as ordered (either benzene or butadiene)

The following accessories are included with the instrument:

- AC Adapter (Battery Charger)
- Travel Charger
- Alkaline battery adapter
- External Filter

Hard-case kits also include these accessories:

- Calibration gas, if specified
- Calibration adapter
- Calibration regulator and flow controller
- Charging cradle (instead of Travel Charger)

AC adapter (battery charger)



WARNING

To reduce the risk of ignition of hazardous atmospheres, recharge battery only in area known to be non-hazardous. Remove and replace battery only in area known to be non-hazardous.

Ne charger les batteries que dans emplacements designés non-dangereuses.

A battery charging circuit is built into the instrument Charging cradle. It only needs a regular AC to 12 VDC adapter (wall-mount transformer, part number 500-0114-000) to charge the instrument.

To charge the battery inside the instrument:

1. Power off the instrument.
2. Connect the AC adapter to the DC jack on the instrument's Charging cradle. If the instrument is off, it automatically turns on.
3. While charging, the display message shows "Charging." The Primary LED on the Charging cradle flashes green when charging.
4. When the battery is fully charged, the LED changes to glowing green continuously, and the message "Fully charged" appears on the display. If there is a charging error, the LED glows red continuously.

A completely discharged instrument can be charged to full capacity within 8 hours. Batteries drain slowly even if an instrument is off. Therefore, if the instrument has been in storage or has not been charged for several days or longer, check the charge before using it.

The factory-supplied battery is designed to last for 16 hours of normal operation (no alarm), for a new battery under the optimum circumstances. As the battery becomes older or is subject to adverse conditions (such as cold ambient temperature), its capacity will be significantly reduced.

Alkaline battery adapter



WARNING

To reduce the risk of ignition of hazardous atmospheres, recharge the battery only in areas known to be non-hazardous. Remove and replace the battery only in areas known to be non-hazardous.

An alkaline battery adapter is supplied with each instrument. The adapter (part number 059-3052-000) accepts four AA alkaline batteries (use only Duracell MN1500) and provides approximately 12 hours of operation. The adapter is intended to be used in emergency situations when there is no time to charge the Li-ion battery pack.

To insert batteries into the adapter:

1. Remove the three Philips-head screws to open the compartment in the adapter.
2. Insert four fresh AA batteries as indicated by the polarity (+/-) markings.
3. Replace the cover. Replace the three screws.

To install the adapter in the instrument:

1. Remove the Li-ion battery pack from the instrument by sliding the tab and tilting out the battery.
2. Replace it with the alkaline battery adapter
3. Slide the tab back into place to secure the battery adapter.

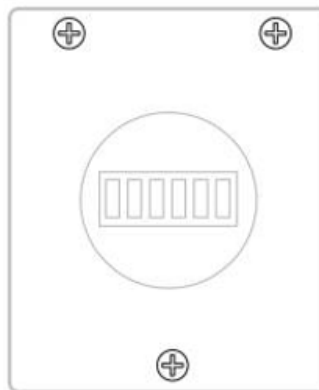

IMPORTANT!

Alkaline batteries cannot be recharged. The instrument's internal circuit detects alkaline batteries and will not allow recharging. If you place the instrument in its Charging cradle, the alkaline battery will not be recharged. The internal charging circuit is designed to prevent damage to alkaline batteries and the charging circuit when alkaline batteries are installed inside the instrument. If you try to charge an alkaline battery installed in the instrument, the instrument's display will say, "Alkaline Battery," indicating that it will not charge the alkaline batteries.

Note: When replacing alkaline batteries, dispose of old ones properly.

External filter



WARNING

Always use an external filter on the instrument. This prevents contaminants and debris from clogging the sample pathway and protects the sensor from damage.

The external filter is made of PTFE (Teflon®) membrane with a 0.45 micron pore size to prevent dust or other particles from being sucked into the sensor manifold, which would cause extensive damage to the instrument. It prolongs the operating life of the sensor. To install the external filter, simply connect it to the instrument's inlet tube.

Optional accessories

Calibration adapter

The calibration adapter for the instrument is a simple 6-inch Tygon tubing. During calibration, simply insert the tubing into the regular gas inlet probe of the instrument and to the gas regulator on the gas bottle.

Calibration regulator

The Calibration Regulator is used in the calibration process. It regulates the gas flow rate from the Span gas cylinder into the gas inlet of the instrument during calibration process. The maximum flow rate allowed by the flow controller is about 0.5L/min (500 cc per min.). Alternatively, a demand-flow regulator or a Tedlar gas bag may be used to match the pump flow precisely.

Organic vapor zeroing kit

The Organic vapor zeroing kit is used for filtering organic air contaminants that may affect the zero calibration reading. To use the Organic vapor zeroing kit, simply connect the filter to the inlet port of the instrument.

AutoRAE 2 automatic test & calibration system

The AutoRAE 2 Automatic Test and Calibration System/portable gas monitors makes compliance with monitor test and calibration requirements as easy as pressing a button. Simply cradle the monitor and the system will take care of all calibration, testing, and recharging.

The AutoRAE 2 is a flexible, modular system that can be configured to meet your calibration requirements effectively and efficiently. An AutoRAE 2 system can be as simple as a single cradle deployed in standalone mode to calibrate one instrument at a time, or as powerful as a networked, controller-based system supporting ten monitors and five distinct calibration gas cylinders.

Standard two-point calibration

Standard Two-Point Calibration (Zero & Span)

The following diagram shows the instrument's calibrations in Basic/Hygiene mode.

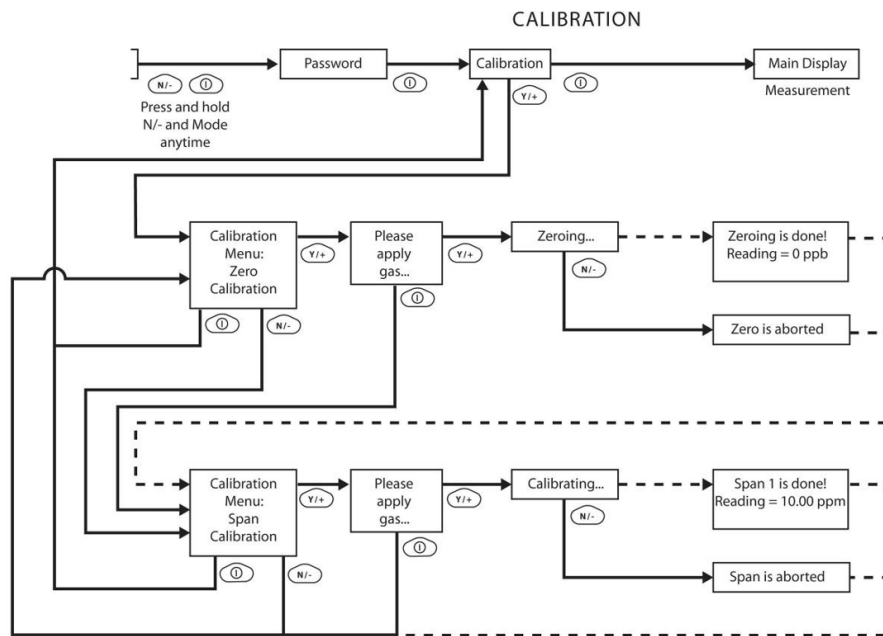

Note: Dashed line indicates automatic progression.

Entering calibration

1. Press and hold [MODE] and [N/-] until you see the Password screen.

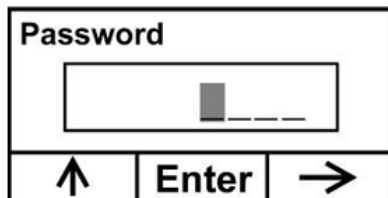

2. In Basic User Level, you do not need a password to perform calibrations. Instead of inputting a password, enter calibration by pressing [MODE].

Note: If you inadvertently press [Y/+] and change any of the numbers, simply press [MODE] and you will be directed to the calibration menu.

The Calibration screen is now visible with Zero Calibration highlighted.

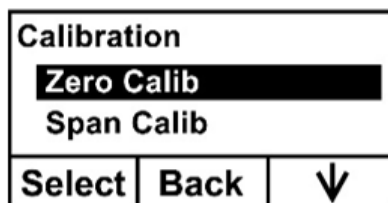

These are your options:

- Press [Y/+] to select the highlighted calibration (Zero Calib or Span Calib).
- Press [MODE] to exit calibration and return to the main display and resume measurement.
- Press [N/-] to toggle the highlighted calibration type.

Zero (Fresh Air) Calibration

This procedure determines the zero point of the sensor calibration curve. To perform a fresh air calibration, use the calibration adapter to connect the instrument to a “fresh” air source such as from a cylinder or Tedlar bag (optional accessory). The “fresh” air is clean, dry air without organic impurities and an oxygen value of 20.9%. If such an air cylinder is not available, any clean ambient air without detectable contaminants or a charcoal filter can be used.

At the Zero Calibration menu, you can proceed to perform a Zero calibration or bypass Zero calibration and perform a Span calibration. You may also go back to the initial Calibration menu if you want to exit calibration.

- Press [Y/+] to start calibration.
- Press [MODE] to quit and return to the main calibration display.

If you have pressed [Y/+] to enter Zero calibration, then you will see this message:

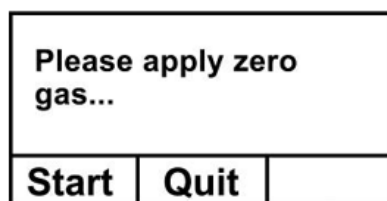

1. Start the flow of Zero calibration gas.
2. Press [Y/+] to start calibration.

Note: At this point, you may press [MODE] if you decide that you do not want to initiate calibration. This will take you directly to the Calibration menu, highlighted for Span calibration.

3. Zero calibration starts a 90-second countdown and displays this message:

Zeroing...

During the zeroing process, the instrument performs the Zero calibration automatically and does not require any action on your part.

Note: To abort the zeroing process at any time and proceed to Span calibration, press [N/-] at any time while zeroing is being performed. You will see a confirmation message that says “Zero aborted!” and then the Span calibration menu appears.

When Zero calibration is complete, you see this message:

Zeroing is done! Zeroing is done!
Reading = 0 ppb or Reading = 0 ppm

The instrument will then show the Calibration menu on its display, with Span Calib highlighted.

Reflex PID Technology™

All handheld PID monitors after firmware version 2.20 benefit from our patented Reflex PID Technology™. It provides several benefits, including enhanced stability and accuracy, particularly at very low levels. One time each hour, Reflex PID™ Technology adjusts the zero point automatically to ensure greater uniformity in readings, especially when detecting ultra-low levels (ppb range) of VOCs. This one-minute operation is performed automatically, so precise readings are assured without requiring the user to perform zeroing.

Reflex PID technology is automatically enabled during each zero calibration process. For the ppbRAE3000+, it performs a sensor noise level assessment to re-baseline zeroing of the instrument and provide ultimate performance at sub-ppm level.

The instrument's user can decide to abort this operation by pressing [N/-], should this process need to be interrupted for a measurement.

Span calibration

This procedure determines the second point of the sensor calibration curve for the sensor. A cylinder of standard reference gas (span gas) fitted with a 500 cc/min. flow-limiting regulator or a flow-matching regulator is the simplest way to perform this procedure. Choose the 500 cc/min. regulator only if the flow rate matches or slightly exceeds the flow rate of the instrument pump. Alternatively, the span gas can first be filled into a Tedlar bag or delivered through a demand-flow regulator. Connect the calibration adapter to the inlet port of the instrument, and connect the tubing to the regulator or Tedlar bag.

Another alternative is to use a regulator with >500 cc/min flow but allow the excess flow to escape through a T or an open tube. In the latter method, the span gas flows out through an open tube slightly wider than the probe, and the probe is inserted into the calibration tube.

At the Span Calibration menu, you perform a Span calibration. You may also go back to the Zero calibration menu or to the initial Calibration menu if you want to exit calibration.

- Press [Y/+] to enter Span calibration.
- Press [N/-] to skip Span calibration and return to Zero calibration.
- Press [MODE] to exit Span calibration and return to the top calibration menu.

If you have pressed [Y/+] to enter Span calibration, then you will see the name of your Span gas (the default is isobutylene) and the span value in parts per million (ppm). You will also see this message that prompts you:

C. Gas = Isobutene		
Span = 10 ppm		
Please apply gas 1...		
Start	Quit	

ppbRAE 3000+

C. Gas = Isobutene		
Span = 100 ppm		
Please apply gas 1...		
Start	Quit	

MiniRAE 3000+, UltraRAE 3000+, MiniRAE Lite+

Note: The default Span value is 100ppm on MiniRAE 3000+ and UltraRAE 3000+, only ppbRAE 3000+ has a value of 10ppm.

1. Turn on your span calibration gas.
2. Press [Y/+] to initiate calibration.

Note: You may press [MODE] if you decide that you do not want to initiate calibration. This will abort the span calibration and take you directly to the Calibration menu for Zero calibration.

3. Span calibration starts and displays this message:

Calibrating...

During the Span calibration process, there is a 30-second countdown and the instrument performs the Span calibration automatically. It requires no actions on your part.

Note: If you want to abort the Span calibration process, press [N/-] at any time during the process. You will see a confirmation message that says “Span is aborted!” and then the Zero calibration menu appears. You can then proceed to perform a Zero calibration, perform a Span calibration, or exit to the topmost Calibration menu.

When Span calibration is complete, you see a message similar to this (the value is an example only):

Span 1 is done!

Reading = 10.0 ppm

The instrument then exits Span calibration and shows the Zero calibration menu on its display.

Note: The reading should be very close to the span gas value.

Exiting two-point calibration in basic user level

When you are done performing calibrations, press [MODE], which corresponds with “Back” on the display.

You will see the following message:

Updating settings...

The instrument updates its settings and then returns to the main display. It begins or resumes monitoring.

Three-point calibration

For enhanced accuracy, it is possible to perform a second Span calibration in addition to the Zero and Span calibrations outlined in the previous section. Your instrument first must be set to allow this third calibration. This requires using Safety Suite Device Configurator (SSDC) software and a PC, as well as a higher concentration of calibration gas. Follow the instructions in the next section.

Note: Once the third calibration is set, you do not need to use SSDC to allow future 3-point calibrations. Also, you can only disable 3-point calibration capability by using SSDC again.

Perform the Zero and Span calibrations. After the first Span calibration (Span 1) is completed, the display a second Span calibration (Span 2) can be performed. The process is identical to the first calibration. As in the Span 1 calibration, you may exit and return to the Zero calibration screen if you choose not to perform this calibration or to abort it.

Note: If a bump test is available, it appears after the last calibration in the menu. See “Two-Point Calibration,” page 42, for details. Also, refer to page 50 for details on how to perform a bump test.

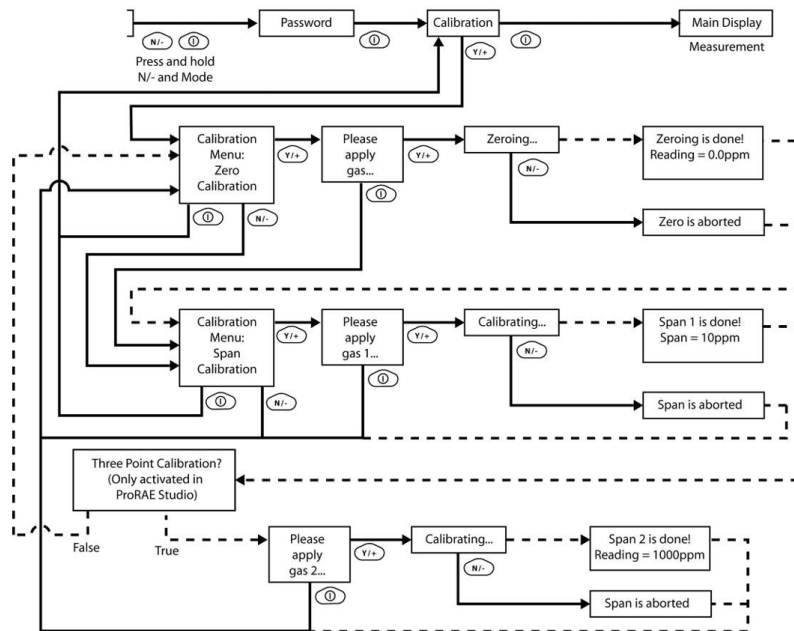

Note: Dashed line indicates automatic progression.

Span 2 calibration

The minimum value of Span 2 gas should be 1000 ppm. If the primary concern is accuracy at low concentration, only using the 2-point calibration process with Span 1 set to 100 ppm is adequate. The reading error at 10 ppm will be lower. If Span 1 is set to 10 ppm, the reading error under 100 ppm (or over 100ppm to 1000 ppm) will be higher. A cylinder of standard reference gas (span gas) fitted with a 500 cc/min. flow-limiting regulator or a flow-matching regulator is the simplest way to perform this procedure.

Note: This gas should be of a higher concentration than the gas used for Span 1 calibration.

Choose the 500 cc/min. regulator only if the flow rate matches or slightly exceeds the flow rate of the instrument pump. Alternatively, the span gas can first be filled into a Tedlar bag or delivered through a demand-flow regulator. Connect the calibration adapter to the inlet port of the instrument, and connect the tubing to the regulator or Tedlar bag.

Another alternative is to use a regulator with >500 cc/min flow but allow the excess flow to escape through a T or an open tube. In the latter method, the span gas flows out through an open tube slightly wider than the probe, and the probe is inserted into the calibration tube.

At the Span Calibration menu, you perform a Span calibration. You may also go back to the Zero calibration menu or to the initial Calibration menu if you want to exit calibration.

- Press [Y/+] to enter Span 2 calibration.
- Press [N/-] to skip Span calibration and return to Zero calibration.
- Press [MODE] to exit Span calibration and return to the top calibration menu.

If you have pressed [Y/+] to enter Span calibration, then you will see the name of your Span gas (the default is isobutylene) and the span value in parts per million (ppm). You will also see this message that prompts you:

Please apply gas...

1. Turn on your span calibration gas.
2. Press [Y/+] to initiate calibration.

Note: You may press [MODE] if you decide that you do not want to initiate calibration. This will take you directly to the Calibration menu for Zero calibration.

3. Span calibration starts a 30-second countdown and displays this message:

Calibrating...

During the Span calibration process, the instrument performs the Span calibration automatically and does not require any action on your part.

Note: If you want to abort the Span calibration process, press [N/-] at any time during the process. You will see a confirmation message that says “Span is aborted!” and then the Zero calibration menu will appear. You can then proceed to perform a Zero calibration, perform a Span calibration, or exit to the topmost Calibration menu.

When Span calibration is complete, you will see a message similar to this (the value shown here is for example only):

Span 2 is done!

Reading = 1000 ppm

The instrument then exits Span calibration and shows the Zero calibration menu on its display.

Note: The reading should be very close to the span gas value.

Exiting three-point calibration

When you are done performing calibrations, press [MODE], which corresponds with “Back” on the display. You will see the following message:

Updating settings...

The instrument updates its settings and then returns to the main display. It begins or resumes monitoring.

14 BUMP TEST

Honeywell recommends that a bump test be conducted prior to each day's use. The purpose of a bump test is to ensure that the instrument's sensors respond to gas and all the alarms are enabled and functional.

- The 3GPID must be calibrated if it does not pass a bump test when a new sensor is installed, after sensor maintenance has been performed, or at least once every 180 days, depending on use and sensor exposure to poisons and contaminants.
- Calibration and bump test intervals and procedures may vary due to national legislation and company policy.

To perform a bump test (functional challenge), follow these steps:

1. Select "Bump."
2. Install the calibration adapter and connect it to a source of calibration gas.
3. Verify that the displayed calibration value meets the concentration specified on the gas cylinder.
4. Press [Y/+] to start the bump test.
5. Start the flow of calibration gas.
6. You can abort the calibration at any time during the countdown by pressing [N/-].
7. If the calibration is not aborted, the display shows reading and then tells you whether the bump test passed or failed. If the bump test failed, then it automatically advances to the Calibration screen.

A bump test can be performed either manually or using the AutoRAE 2 Automatic Test and Calibration System. When a bump test is done manually, the instrument makes a pass/fail decision based on sensor performance, but the user still has the responsibility to make sure all the alarms are enabled and functional.

Note: Bump testing and calibration can be performed using an AutoRAE 2 Automatic Test & Calibration System. An AutoRAE 2 bump test takes care of both the sensor and alarm tests. Consult the AutoRAE 2 User's guide for details.

The same gas is used for a bump test as for calibration. The instrument must be connected to a cylinder of calibration gas with supplied tubing.

IMPORTANT!

If the instrument does not pass a bump test, perform a full calibration. If calibration also fails, the PID sensor or lamp may require cleaning or replacement. If the instrument repeatedly fails to calibrate, turn it off and refer it for servicing.

PROGRAMMING MODE

On the MiniRAE 3000+, ppbRAE 3000+, or UltraRAE 3000+, Programming Mode can be entered from either Hygiene Mode or Search Mode. If the current user mode is Basic, you must provide a 4-digit password to enter. The MiniRAE Lite+ has only Search mode.

Manual datalog

When the instrument is set to Manual Datalog, you turn datalogging on and off by stepping through the displays from the Main Display, and then pressing the keys to select datalog on/off functions.

- When you reach the screen that says “Start Datalog?” press [Y/+] to start it. You see “Datalog Started,” confirming that datalogging is now on.
- When you reach the screen that says “Stop Datalog?” press [Y/+] to stop it. You see “Datalog Stopped,” confirming that datalogging is now off.

Snapshot datalog

When the instrument is in Snapshot datalogging mode, it captures a single “snapshot” of the data at the moment of your choosing. Whenever the instrument is on and it is set to Snapshot, all you have to do is press [MODE] each time you want to capture a snapshot of the data at that instant.

When you send the data to a computer using Safety Suite Device Configurator (SSDC), the data snapshots are uniquely identified by time and other parameters.

Entering programming mode

Note: The default password is 0000.

1. Press and hold [MODE] and [N/-] until you see the Password screen.

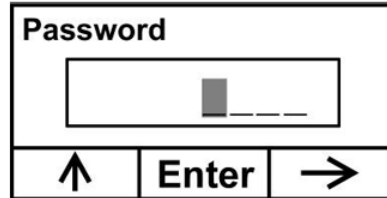

2. Input the 4-digit password:
 - Increase the number from 0 through 9 by pressing [Y/+].
 - Step from digit to digit using [N/-].
 - Press [MODE] when you are done.

If you make a mistake, you can cycle through the digits by pressing [N/-] and then using [Y/+] to change the number in each position.

When you have successfully entered Programming Mode, you see this screen:

Calibration

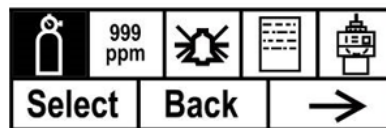

Note: The password can only be changed by connecting the instrument to a PC running Safety Suite Device Configurator (SSDC) software. Follow the instructions in SSDC to change it. The Calibration label is shown and its icon is highlighted, but you can press [N/-] to step from one programming menu to the next, with the name of the menu shown at the top of the display and the corresponding icon highlighted.

As you repeatedly press [N/-], the selection moves from left to right, and you see these screens:

MiniRAE 3000+, ppbRAE 3000+, UltraRAE 3000+

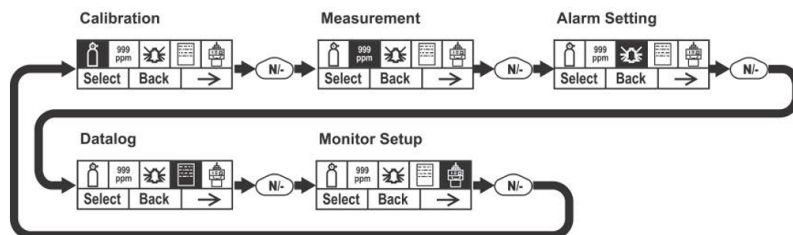

MiniRAE Lite+

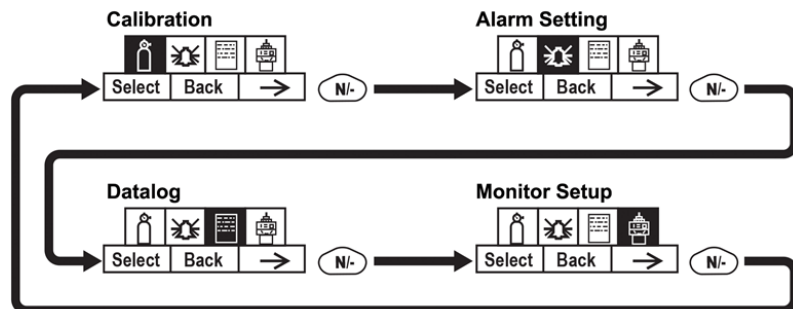

Note: When you reach Monitor Setup and press [N/-], the menu cycles back to Calibration.

Programming mode menus

The Programming Mode allows anyone with the password to change the instrument's settings, calibrate the instrument, modify the sensor configuration, enter user information, etc. Programming Mode has five menus. Each menu includes several sub-menus to perform additional programming functions.

The table on the next shows the menus and sub-menus.

All entries are supported on MiniRAE 3000+, ppbRAE 3000+, and UltraRAE 3000+.

Entries marked with an asterisk (*) are supported on MiniRAE Lite+.

Note: If the instrument is non-wireless the options will be crossed out.

				
Calibration	Measurement	Alarm Setting	Datalog	Monitor Setup
Zero Calibration *	Meas. Gas	High Alarm *	Clear Datalog *	Radio Power*
Span Calibration *	Meas. Unit	Low Alarm *	Interval *	Op Mode
Bump *	Tube Selection	STEL Alarm	Data Selection *	Site ID
		TWA Alarm	Datalog Type *	User ID
		Alarm Mode *		User Mode
		Buzzer & Light *		Date *
				Time *
				Pump Duty Cycle
				Pump Speed
				Temperature Unit
				Language *
				Power On Zero*
				Real Time Protocol*
				Unit ID
				Lamp ID
				PAN ID*

				Mesh Channel*
				Mesh Interval*
				LCD Contrast*

Once you enter Programming Mode, the LCD displays the first menu, Calibration. Each subsequent menu is accessed by pressing [N/] repeatedly until the desired menu is displayed. To enter a sub-menu of a menu, press [Y/+].

Exiting programming mode

To exit Programming Mode and return to normal operation, press [MODE] once at any of the programming menu displays. You will see “Updating Settings...” as changes are registered and the mode changes.

Navigating programming mode menus

Navigating through the Programming Mode menus is easy and consistent, using a single interface format of “Select,” “Back” and “Next” at the top level. The three control buttons correspond to these choices as shown:

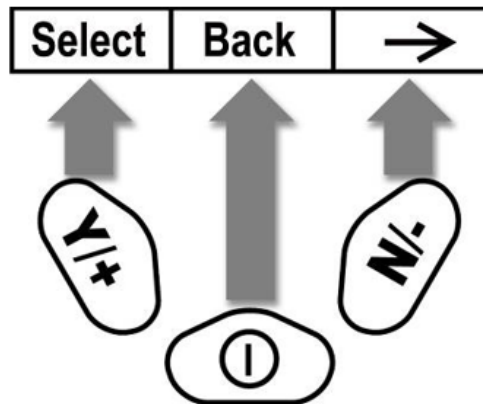

Note: Pressing [MODE] in the Programming Mode’s top level causes the instrument to exit Programming Mode and return to monitoring.

The three keys perform the following functions in Programming Mode:

Key	Function in Programming Mode
[MODE]:	Exit menu when pressed momentarily or exit data entry mode
[Y/+]:	Increase alphanumerical value for data entry or confirm (yes) for a question
[N/-]:	Provides a “no” response to a question

Reverse direction – menu selection

Lists can be long, so rather than progressing in one direction through every item in the list before “looping” back to the first item, you can change the scrolling direction.

To reverse direction: Press and hold [N/-] for 5 seconds. The direction arrow changes. Now when you press [N/-], the menu items are scrolled through in the other direction.

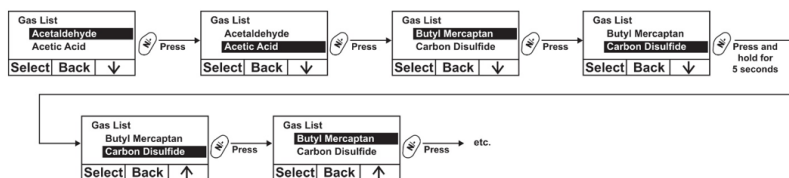

Note: You can change direction anytime by pressing and holding [N/-] for 5 seconds.

Calibration

Two types of calibration are available: Zero (fresh air) and Span.

Calibration



MiniRAE 3000+, ppbRAE 3000+, UltraRAE

Calibration

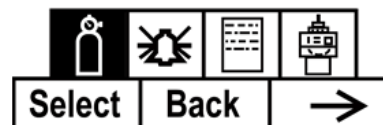

MiniRAE Lite+

Select Zero or Span Calibration by pressing [N/+]. Once your choice is highlighted, press [Y/+].

Zero calibration

For the procedure for performing a zero calibration See "Zero (Fresh Air) Calibration" on page 61 for more information..

Auto Zero can also be performed. See "Auto-zero at startup" on page 28 for more information.

Span calibration

For the procedure for performing a basic span calibration See "Span calibration" on page 62 for more information.

Bump test

For the procedure for performing a bump test See "Bump test" on page 67 for more information.

A bump test can be performed either manually or using the AutoRAE 2 Automatic Test and Calibration System. When a bump test is done manually, the instrument makes a pass/fail decision based on sensor performance, but the user still has the responsibility to make sure all the alarms are enabled and functional.

Note: Bump testing and calibration can be performed using an AutoRAE 2 Automatic Test & Calibration System. An AutoRAE 2 bump test takes care of both the sensor and alarm tests. Consult the AutoRAE 2 User's guide for details.

The same gas is used for a bump test as for calibration. The instrument must be connected to a cylinder of calibration gas with supplied tubing.

IMPORTANT!

If the instrument does not pass a bump test, perform a full calibration. If calibration also fails, the PID sensor or lamp may require cleaning or replacement. If the instrument repeatedly fails to calibrate, turn it off and refer it for servicing.

Measurement

The sub-menus for Measurement are Measurement Gas and Measurement Unit.

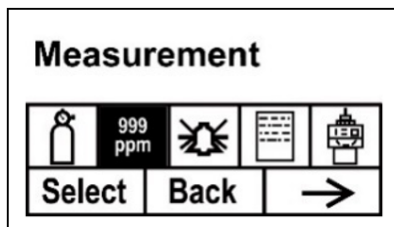

Measurement gases

Note: This feature is not available in the MiniRAE Lite+

Measurement gases are organized in four lists:

- My List is a customized list of gases that you create. It contains a maximum of 10 gases and can only be built in Safety Suite Device Configurator (SSDC) on a PC and transferred to the instrument.

Note: The first gas in the list is always isobutylene (it cannot be removed from the list).

- Last Ten is a list of the last ten gases used by your instrument. The list is built automatically and is only updated if the gas selected from Custom Gases or Library is not already in the Last Ten. This ensures that there is no repetition.
- Gas Library is an internal library that consists of all the gases that have been evaluated and most have been tested with our instruments. Between 70% and 80% of the Correction Factors (CF) have been tested for accuracy. **Note:** They are specific to the instrument and should not be applied to other instruments.
- Custom Gases are gases with user-modified parameters. Using Safety Suite Device Configurator (SSDC), all parameters defining a gas can be modified, including the name, span value(s), correction factor, and default alarm limits.

1. Scroll through each list by pressing [N/-].
2. Press [Y/+] to select one (My List, Last Ten, Gas Library, or Custom Gases).
3. Once you are in one of the categories, press [N/-] to scroll through its list of options and [Y/+] to select one. (If you press [MODE], you exit to the next submenu.)
4. Press [Y/+] to save your choice or [N/-] to undo your selection.

Press [MODE] to leave the sub-menu and return to the Programming Mode menus.

IMPORTANT!

All Correction Factors (CF) are calculated relative to Isobutylene. From firmware version v2.22, for every instrument (except MiniRAE Lite) and lamp, if the calibration gas is not isobutylene, you may only use the “Custom Gas” option to input a Correction Factor.

CFs of VOCs relative to real-time calibration gas were calculated based on the CFs of the VOCs relative to isobutylene, using the formula $CF = CF1 / CF2$, where CF1 is the measurement gas CF relative to isobutylene and CF2 is calibration gas CF relative to isobutylene, CF is the final value included in the “Custom Gas” information.

If another gas is selected for calibration instead of Isobutylene, the instrument prevents you from selecting “My Lst”, “Last Ten,” or “Gas Library.” Only the “Custom Gas” option is available.

Measurement units

Standard available measurement units include:

Abbreviation	Unit
ppm	parts per million
ppb	parts per billion
mg/m ³	milligrams per cubic meter
ug/m ³	micrograms per cubic meter

- Scroll through the list by pressing [N/-].
- Select by pressing [Y/+].
- Save your selection by pressing [Y/+] or undo your selection by pressing [N/-].

Press [MODE] to leave the sub-menu and return to the Programming Mode menus.

Tube selection (UltraRAE 3000+ only)

When operating the UltraRAE 3000+ in Compound Specific mode, the internal computer works most effectively when it is told which type of separation tube is being used.

Tube Selection		
<input checked="" type="radio"/>	Benzene	
<input type="radio"/>	Butadiene	
Select	Done	↓

1. Scroll through the menu by pressing [N/-].
2. Press [Y/+] to make a selection.
3. Press [MODE] when you are done.
4. Press [Y/+] to save your choice or [N/-] to undo your selection.

Tube Selection		
<input checked="" type="radio"/>	Benzene	
<input type="radio"/>	Butadiene	
Select	Done	↓

Alarm setting

During each measurement period, the gas concentration is compared with the programmed alarm limits (gas concentration alarm limit settings: Low, High, TWA and STEL). If the concentration exceeds any of the preset limits, the loud buzzer and red flashing LED are activated immediately to warn of the alarm condition.

See "Alarm signal summary" on page 49 for more information.

In this menu, you can change the High and Low alarm limits, the STEL limit, and the TWA. Press [Y/+] to enter the Alarm Setting menu. **Note:** All settings are shown in ppm (parts per million), or mg/m³ (milligrams per cubic meter), depending on your setting.

Alarm Setting



MiniRAE 3000+, ppbRAE 3000+, UltraRAE

Alarm Setting



MiniRAE Lite+

1. Scroll through the Alarm Limit sub-menu using the [N/-] key until the display shows the desired limit to be changed (High Alarm, Low Alarm, STEL Alarm, and TWA Alarm)
2. Press [Y/+] to select one of the alarm types. The display shows a flashing cursor on the left-most digit of the previously stored alarm limit.
3. Press [Y/+] to increase each digit's value.
4. Press [N/-] to advance to the next digit.
5. Again, use [Y/+] to increase the number.

Repeat this process until all numbers are entered.

Press [MODE] when you are done.

- Press [Y/+] to save the changes.
- Press [N/-] to undo the changes and revert to the previous settings.

When all alarm types have been changed or bypassed, press [MODE] to exit to the Programming Menu.

High alarm

You can change the High Alarm limit value. The value is typically set by the instrument to match the value for the current calibration gas. It is expressed in parts per billion (ppb). **Note:** The default value depends on the measurement gas.

To change the High Alarm value:

1. Press [Y/+] to increase each digit's value.
2. Press [N/-] to advance to the next digit.
3. Again, use [Y/+] to increase the number.

Repeat this process until all numbers are entered.

When you have completed your selections, press [MODE]. You will see two choices: Save and Undo. You have the opportunity to register the new settings or to change your mind and revert to your previous settings.

- Press [Y/+] to save the changes.
- Press [N/-] to undo the changes and revert to the previous settings.

Low alarm

You can change the Low Alarm limit value. The value is typically set by the instrument to match the value for the current calibration gas. It is expressed in parts per billion (ppb). **Note:** The default value depends on the measurement gas.

To change the Low Alarm value:

1. Press [Y/+] to increase each digit's value.
2. Press [N/-] to advance to the next digit.
3. Again, use [Y/+] to increase the number.

Repeat this process until all numbers are entered.

When you have completed your selections, press [MODE]. You will see two choices: Save and Undo. You can register the new settings or to change your mind and revert to your previous settings.

- Press [Y/+] to save the changes.
- Press [N/-] to undo the changes and revert to the previous settings.

STEL alarm

Note: This feature is not included on MiniRAE Lite+.

You can change the STEL Alarm limit value. The value is typically set by the instrument to match the value for the calibration gas. It is expressed in parts per billion (ppb). **Note:** The default value depends on the measurement gas.

To change the STEL Alarm value:

1. Press [Y/+] to increase each digit's value.
2. Press [N/-] to advance to the next digit.
3. Again, use [Y/+] to increase the number.

Repeat this process until all numbers are entered.

When you have completed your selections, press [MODE]. You will see two choices: Save and Undo. You can register the new settings or to change your mind and revert to your previous settings.

- Press [Y/+] to save the changes.
- Press [N/-] to undo the changes and revert to the previous settings.

TWA alarm

Note: This feature is not included on MiniRAE Lite+.

You can change the TWA (time-weighted average) Alarm limit value. The value is typically set by the instrument to match the value for the calibration gas. It is expressed in parts per billion (ppb).

Note: The default value depends on the measurement gas.

To change the TWA Alarm value:

1. Press [Y/+] to increase each digit's value.
2. Press [N/-] to advance to the next digit.
3. Again, use [Y/+] to increase the number.

Repeat this process until all numbers are entered.

When you have completed your selections, press [MODE]. You will see two choices:

- Save
- Undo

You can register the new settings or to change your mind and revert to your previous settings.

- Press [Y/+] to save the changes.
- Press [N/-] to undo the changes and revert to the previous settings.

Alarm mode

There are two selectable alarm types:

Latched When the alarm is triggered, you can manually stop the alarm.

The latched setting only controls alarms for High Alarm, Low Alarm, STEL Alarm, and TWA alarm.

Note: To clear an alarm when the instrument is set to “Latched,” press [Y/+] when the main (Reading) display is shown. Take into account that the pump alarm is always latched.

Automatic Reset When the alarm condition is no longer present, the alarm stops and resets itself.

1. Press [N/-] to step from one alarm type to the other.
2. Press [Y/+] to select an alarm type.

When you have completed your selections, press [MODE].

You will see two choices: Save and Undo. You have the opportunity to register the new settings or to change your mind and revert to your previous settings.

- Press [Y/+] to save the changes.
- Press [N/-] to undo the changes and revert to the previous settings.

Buzzer & light

The buzzer and light alarms can be programmed to be on or off individually or in combination. Your choices are:

- Both on
- Light only
- Buzzer only
- Both off

1. Press [N/-] to step from one option to the next.
2. Press [Y/+] to make your selection (the dark circle in the “radio button” indicates your selection).
3. When you have completed your selections, press [MODE].

You will see two choices: Save and Undo. You have the opportunity to register the new settings or to change your mind and revert to your previous settings.

- Press [Y/+] to save the changes.
- Press [N/-] to undo the changes and revert to the previous settings.

Datalog

The instrument calculates and stores the concentration and ID of each sample taken. In the datalog sub-menu, a user can perform the tasks and functions shown below.

Datalog

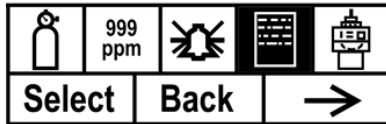

MiniRAE 3000+, ppbRAE 3000+, UltraRAE

Datalog

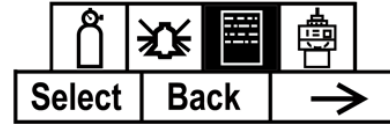

MiniRAE Lite+

1. Scroll through the Datalog sub-menu using the [N/-] key until the display shows the desired parameter to be changed:
 - Clear Datalog
 - Interval
 - Data Selection
 - Datalog Type
2. Press [Y/+] to make your selection. Exit by pressing [MODE] for Back.

Clear datalog

This erases all the data stored in the datalog.

Note: Once the datalog is cleared, the data cannot be recovered.

Press [Y/+] to clear the datalog. The display asks, “Are you sure?”

- Press [Y/+] if you want to clear the datalog. When it has been cleared, the display shows “Datalog Cleared!”
- Press [N/-] if you do not want to clear the datalog.

The display changes, and you are taken to the next sub-menu, Interval.

Interval

Intervals are shown in seconds. The default value is 60 seconds. The maximum interval is 3600 seconds.

1. Press [Y/+] to increase each digit's value.
2. Press [N/-] to advance to the next digit.
3. Again, use [Y/+] to increase the number.

Repeat this process until all numbers are entered.

When you have completed your selections, press [MODE].

You will see two choices: Save and Undo. You can register the new settings or to change your mind and revert to your previous settings.

- Press [Y/+] to save the changes.
- Press [N/-] to undo the changes and revert to the previous settings.

Data selection

Data Selection allows you to select which types of data are stored and made available when you offload your datalog to a computer via Safety Suite Device Configurator (SSDC) software.

You can choose any or all of four types of data (you must choose at least one):

- Average
- Maximum
- Minimum
- Realtime

1. Press [N/-] to step from one option to the next. The highlighter indicates your choice.
2. Press [Y/+] to toggle your selection on or off (the check box indicates "on" with an "X").
3. When you have completed your selections, press [MODE].

You will see two choices: Save and Undo. You can register the new settings or to change your mind and revert to your previous settings.

- Press [Y/+] to save the changes.
- Press [N/-] to undo the changes and revert to the previous settings.

Datalog type

The instrument has three datalog types:

- Auto Default mode. Collects datalog information when the instrument is sampling.
- Manual Datalogging occurs only when the instrument's datalogging is manually started (see below for details).
- Snapshot Datalogs only during single-event capture sampling.

Note: You can only choose one datalog type to be active at a time.

1. Press [N/-] to step from one option to the next.
2. Press [Y/+] to make your selection (the dark circle in the “radio button” indicates “on”).
3. When you have completed your selection, press [MODE].

You will see two choices: Save and Undo. You can register the new settings or to change your mind and revert to your previous settings.

- Press [Y/+] to save the changes.
- Press [N/-] to undo the changes and revert to the previous settings.

Manual datalog

When the instrument is set to Manual Datalog, you turn datalogging on and off by stepping through the displays from the Main Display, and then pressing the keys to select datalog on/off functions.

- When you reach the screen that says “Start Datalog?” press [Y/+] to start it. You see “Datalog Started,” confirming that datalogging is now on.
- When you reach the screen that says “Stop Datalog?” press [Y/+] to stop it. You see “Datalog Stopped,” confirming that datalogging is now off.

Snapshot datalog

When the instrument is in Snapshot datalogging mode, it captures a single “snapshot” of the data at the moment of your choosing. Whenever the instrument is on and it is set to Snapshot, all you have to do is press [MODE] each time you want to capture a snapshot of the data at that instant.

When you send the data to a computer using Safety Suite Device Configurator (SSDC), the data snapshots are uniquely identified by time and other parameters.

Monitor setup

Many settings can be accessed in this menu, including setting the date and time and adjusting the pump's on/off duty cycle.

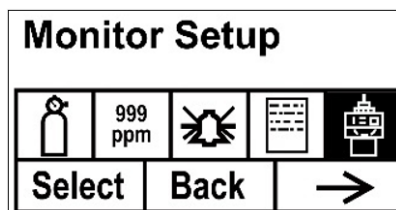

MiniRAE 3000+, ppbRAE 3000+, UltraRAE 3000+

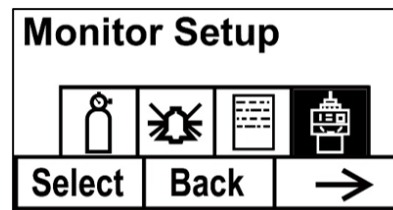

MiniRAE Lite+

Radio power

The radio connection can be turned on or off. (The default value is off.)

1. Press [N/-] to step from one option to the next (on or off).
2. Press [Y/+] to make your selection (the dark circle in the "radio button" indicates that the option is selected).
3. When you have completed your selection, press [MODE].
 - Press [Y/+] to accept the new radio setting (on or off).
 - Press [N/-] to discard the change and move to the next sub-menu.

Op mode

Note: This feature is not included on MiniRAE Lite+.

Under Monitor Setup is "Op Mode."

Press [Y/+] to select.

You see two options (one is highlighted):

- Hygiene
- Search

The current mode is indicated by a dark circle within the circle in front of either Hygiene or Search.

1. Select Hygiene or Search by pressing [N/-]. The highlighting changes from one to the other each time you press [N/-].
2. Press [Y/+] to select that mode for the instrument.
3. Press [MODE] when you want to register your selection to place the instrument in the selected mode.
4. Press [Y/+] to commit the change and exit to the Monitor Setup screen, or press [N/-] to Undo (exit to the Monitor Setup screen without changing the Mode).

Site ID

Enter an 8-digit alphanumeric/character Site ID in the programming mode. This Site ID is included in the datalog report.

1. Press [Y/+] and the display shows the current site ID. Example: "RAE00001." Note that the left-most digit flashes to indicate it is the selected one.
2. Press [Y/+] to step through all 26 letters (A to Z) and 10 numerals (0 to 9).

Note: The last four digits must be numerals which increase each time a sample is taken in Site ID.

3. Press [N/-] to advance to the next digit. The next digit to the right flashes.
4. Repeat this process until all eight digits of the new site ID are entered.

Press [MODE] to exit.

If there is any change to the existing site ID, the display shows "Save?" Press [Y/+] to accept the new site ID. Press [N/-] to discard the change and move to the next sub-menu.

User ID

Enter an 8-digit alphanumeric User ID in the programming mode. This User ID is included in the datalog report and can be used as a naming device for SSR and EchoView Host.

1. Press [Y/+] and the display shows the current User ID. Example: "RAE00001." Note that the left-most digit flashes to indicate it is the selected one.
2. Press [Y/+] to step through all 26 letters (A to Z) and 10 numerals (0 to 9).
3. Press [N/-] to advance to the next digit. The next digit to the right flashes.
4. Repeat this process until all eight digits of the new User ID are entered.

Press [MODE] to exit.

If there is any change to the existing User ID, the display shows "Save" press [Y/+] to accept the new site ID. Press [N/-] to discard (undo) the change and move to the next sub-menu.

User mode

Note: This feature is not included on MiniRAE Lite+.

The instrument has two user modes:

- | | |
|----------|---|
| Basic | Basic users can only see and use a basic set of functions. |
| Advanced | Advanced users can see all screens and perform all available functions. |

Note: The default value for User Mode is Basic.

To change the User Mode:

1. Press [N/-] to step from one option to the next. The highlighting changes each time you press [N/-].
2. Press [Y/+] to make your selection (the dark circle in the “radio button” indicates “on”).
3. When you have completed your selection, press [MODE].
4. Press [Y/+] to accept the new User Mode. Press [N/-] to discard the change and move to the next sub-menu.

Date

The Date is expressed as Month/Day/Year, with two digits for each.

1. Press [Y/+] and the display shows the current date. Note that the left-most digit flashes to indicate it is selected.
 2. Press [Y/+] to step through all 10 numerals (0 to 9).
 3. Press [N/-] to advance to the next digit. The next digit to the right flashes.
 4. Repeat this process until all six digits of the new date are entered.
 5. Press [MODE] to exit.
- Press [Y/+] to save the new date.
 - Press [N/-] to undo the change and move to the next sub-menu.

Time

The Time is expressed as Hours/Minutes/Seconds, with two digits for each. The time is in 24-hour (military) format.

1. Press [Y/+] and the display shows the current time. Note that the left-most digit flashes to indicate it is selected.
 2. Press [Y/+] to step through all 10 numerals (0 to 9).
 3. Press [N/-] to advance to the next digit. The next digit to the right flashes.
 4. Repeat this process until all six digits of the new time are entered.
 5. Press [MODE] to exit.
- Press [Y/+] to save the new date.
 - Press [N/-] to undo the change and move to the next sub-menu.

Duty cycle

The pump's duty cycle is the ratio of its on time to off time. The duty cycle ranges from 50% to 100% (always on). Duty cycling is employed by the instrument to clean the PID. A lower duty cycle has a greater effect on keeping the PID clean than a higher duty cycle.

Important! Pump duty cycling is interrupted when the instrument senses a gas. The pump's duty cycle is disabled when the measurement is greater than the low-alarm threshold and is re-enabled when the reading falls below the low-alarm threshold. The interval range is 10 to 300 seconds, and the default value is 30. It can also be programmed via the Safety Suite Device Configurator (SSDC) program.

1. Press [Y/+] to increase the value.
 2. When you have completed your selection, press [MODE].
- Press [Y/+] to save the new duty cycle value.
 - Press [N/-] to undo the change and move to the next sub-menu.

Temperature unit

The temperature display can be switched between Fahrenheit and Celsius units.

1. Press [N/-] to step from one option to the next.
 2. Press [Y/+] to make your selection (the dark circle in the "radio button" indicates "on").
 3. When you have completed your selection, press [MODE].
- Press [Y/+] to save the new temperature unit.
 - Press [N/-] to undo the change and move to the next sub-menu.

Pump speed

The pump can operate at two speeds, high and low. Running at low speed is quieter and conserves a small amount of power. There is almost no difference in sampling accuracy. If extension tubing is attached, it is recommended to use high speed pump.

1. Press [N/-] to step from one option to the next.
 2. Press [Y/+] to make your selection (the dark circle in the "radio button" indicates "on").
 3. When you have completed your selection, press [MODE].
- Press [Y/+] to save the new temperature unit.
 - Press [N/-] to undo the change and move to the next sub-menu.

Language

English is the default language, but other languages can be selected for the instrument.

1. Press [N/-] to step from one option to the next.
 2. Press [Y/+] to make your selection (the dark circle in the “radio button” indicates “on”).
 3. When you have completed your selection, press [MODE].
- Press [Y/+] to save your new language choice.
 - Press [N/-] to undo it and return to the previous language selection.

Real Time protocol

Real Time Protocol is the setting for data transmission.

The choices are:

- P2M (cable) Point to multipoint. Data is transferred from the instrument to multiple locations using a wired connection. Default data rate: 19200 bps.
- P2P (cable) Point to point. Data is transferred only between the instrument and one other location, such as a computer. Default data rate: 9600 bps.
- Wireless Data is transferred wirelessly and can be received by receivers.

1. Press [N/-] to step from one option to the next.
 2. Press [Y/+] to make your selection (the dark circle in the “radio button” indicates “on”).
 3. When you have completed your selection, press [MODE].
- Press [Y/+] to save the new real-time communications protocol.
 - Press [N/-] to undo the change and move to the next sub-menu.

Auto-Zero at startup

Note: This is not recommended for ppbRAE3000+ or UltraRAE3000+.

Always make sure the instrument is turned on in VOC-free environment. When Auto-Zero At Startup is on, the instrument performs a zero calibration when it is turned on.

1. Press [N/-] to step from one option to the next.
 2. Press [Y/+] to make your selection (the dark circle in the “radio button” indicates your selection).
 3. When you have completed your selection, press [MODE].
- Press [Y/+] to save the change.
 - Press [N/-] to discard the change and move to the next sub-menu.

Unit ID

This three-digit number keeps data separated by instrument when more than one instrument is used in a network. If multiple sensing units are attempting to communicate with the same Host, then the units must all have a different Unit ID.

1. Press [Y/+] to step through all 10 numerals (0 to 9). If you pass the numeral you want, keep pressing [Y/+] until it counts up to 9, it starts counting up from 0 again.
 2. Press [N/-] to advance to the next digit. The next digit to the right flashes.
 3. Repeat this process until all three digits of the Unit ID are entered.
 4. Press [MODE] when you are done.
- Press [Y/+] to save the change.
 - Press [N/-] to discard the change and move to the next sub-menu

NOTE: Unit ID is mainly for the 3G Handheld PIDs with the 2.0 Bluetooth Wireless Modems. For instruments with Mesh Modem options, the Unit ID is set in the RAELINK3-Mesh.

LCD contrast

The display's contrast can be increased or decreased from its default setting. You may not need to ever change the default setting, but sometimes you can optimize the display to suit extreme temperature and ambient brightness/darkness conditions.

- The minimum value is 20.
 - The maximum value is 60.
1. Press [Y/+] to increase the value or [N/-] to decrease the value.
 2. Press [MODE] to save your selection.
- Press [Y/+] to save your new contrast value.
 - Press [N/-] to undo it and return to the previous value.

Lamp ID

The instrument does not automatically identify the type of lamp installed. If the lamp type is replaced with a different UV Lamp energy, you must select the lamp type.

1. Scroll through the menu by pressing [N/-].
2. Press [Y/+] to make a selection.
3. Press [MODE] when you are done.
4. Press [Y/+] to save your choice or [N/-] to undo your selection.

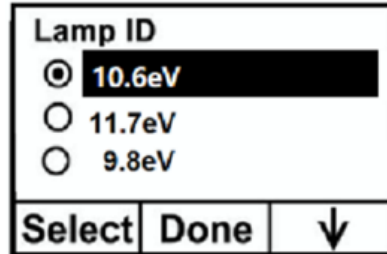

PAN ID

The instrument and any other devices that you want to interconnect wirelessly must have the same PAN ID. You can set the PAN ID in the instrument or through Safety Suite Device Configurator (SSDC).

1. Press [N/-] to advance through the digits from left to right.
2. Press [Y/+] to advance through the numbers (1, 2, 3, etc.).
3. Press [MODE] to register your choice when you are done.

Note: PAN ID only applies to instruments equipped with a MESH Radio Modem, not BLE or BT.

Mesh channel

Note: For mesh radio modems operating at 868MHz, only channel 0 is available. For other frequencies, channels 1 through 10 are allowed.

1. Press [Y/+] to increase the number and [N/-] to advance to the next digit.
2. After moving to the last digit and making changes, press [MODE].
 - Press [Y/+] to save the change.
 - Press [N/-] to undo the change.

Note: Mesh Channel only applies to instruments equipped with a MESH Radio Modem, not BLE or BT.

Mesh interval

Set the time interval at which the instrument's mesh radio sends out a signal. This can range from once every 10 seconds to once every four minutes (240 seconds). The transmission frequency is user-adjustable, but a rate of at least once every 30 seconds is recommended.

Note: Shorter intervals reduce battery life.

1. Press [N/-] to step from one option to the next.
2. Press [Y/+] to make a selection.
3. When you are done, press [MODE].

Note: Mesh Interval only applies to instruments equipped with a MESH Radio Modem, not BLE or BT.

16 HYGENE MODE

Note: This feature is not included on MiniRAE Lite+.

The instrument usually operates in Hygiene Mode, which provides basic functionality. However, it is possible to operate it in a second mode called Search Mode. Here are the primary differences:

- Hygiene Mode:** Automatic measurements, continuously running and datalogging, and calculates additional exposure values.
- Search Mode:** Manual start/stop of measurements and display of certain exposure values.

Basic user level & hygiene mode

The default setting is navigated in the following way:

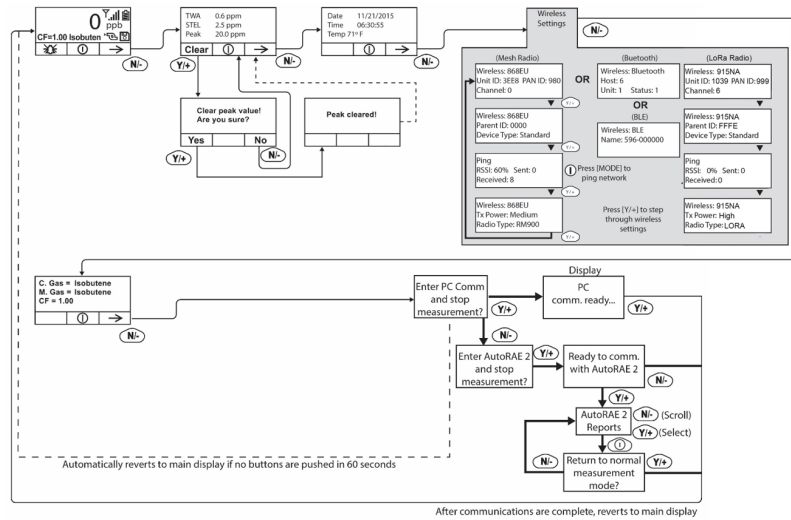

Note: Dashed line indicates automatic progression.

Pressing [N/-] steps you from screen to screen. Options include clearing the Peak value and turning on the instrument's PC Communications for data transfer to a PC or AutoRAE 2.

Entering search mode from hygiene mode

In order to change the instrument's operational mode from Hygiene Mode to Search Mode, you must enter the password-protected Programming Mode:

1. Hold [MODE] and [N/-] until you see the password screen.
2. Use [Y/+] to increment to the number you want for the first digit. (If you pass by the desired number, press [Y/+] until it cycles through to 0 again. Then press [Y/+] until you reach the desired number.)
3. Press [N/-] to advance to the next digit.
4. Again press [Y/+] to increment the number.
5. Press [N/-] to advance to the next digit.

Continue the process until all four numbers of the password have been input. Then press [MODE] to proceed.

The screen changes to icons with the label "Calibration."

1. Press [N/-] to advance to "Monitor Setup."
2. Press [Y/+] to select Monitor Setup.
Under Monitor Setup, you will see "Op Mode."
3. Press [Y/+] to select.

You will see:

Hygiene
Search

The current mode is indicated by a dark circle within the circle in front of either Hygiene or Search.

1. Select Hygiene or Search by pressing [N/-].
2. Press [Y/+] to place the instrument into the selected mode.
3. Press [MODE] when you want to register your selection to place the instrument in the selected mode.
4. Press [Y/+] to commit the change and exit to the Monitor Setup screen, or press [N/-] to Undo (exit to the Monitor Setup screen without changing the Mode).

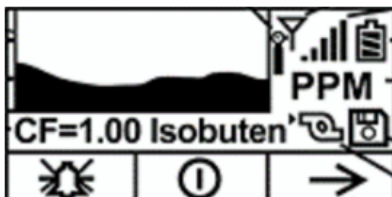

Rolling Graph: Gives you a visual guidance to seek a source. Use the Safety Suite Device Configurator (SSDC) Software to enable this feature.

The User Mode called Advanced User Level allows a greater number of parameters to be changed than Basic User Level. It can be used with either of the Operation Modes, Hygiene Mode or Search Mode.

Advanced user level & hygiene mode

With the instrument in Operation Mode: Hygiene Mode, enter User Mode: Advanced User Level (refer to the section called Monitor Mode for instructions).

Once you are in Advanced User Level and Hygiene Mode together, you can change the calibration reference and measurement gas, in addition to performing normal monitoring functions.

Pressing [N/-] progresses through the screens, while pressing [Y/+] selects options. Pressing [MODE] makes menu choices when it is shown for “Done” or “Back.” Pressing and holding [Mode] whenever the circle with a vertical line in the middle is shown activates the countdown to shutoff.

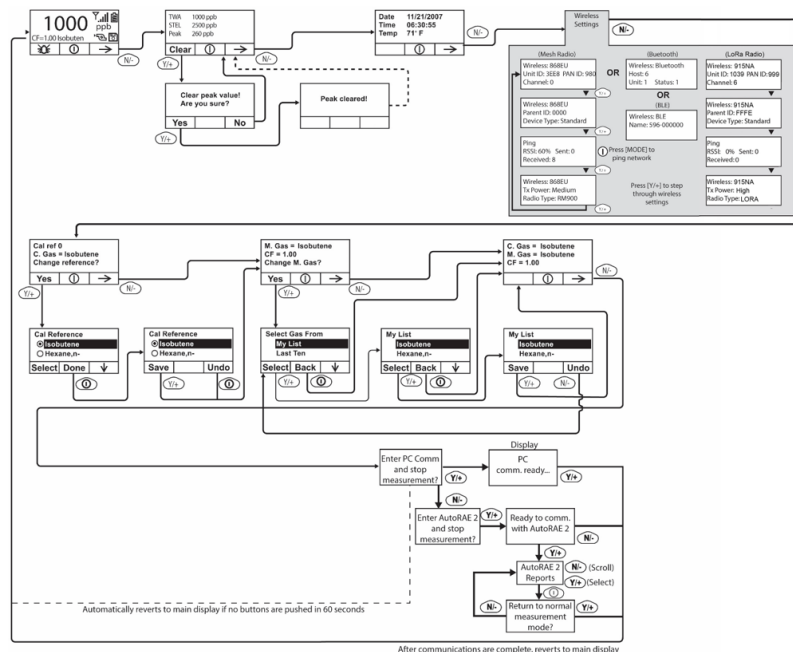

Note: Dashed line indicates automatic progression.

Basic user level & search mode

With the instrument in Operation Mode in MiniRAE Lite+: Search Mode, enter User Mode and select Basic User Level (refer to the section called User Mode for instructions).

When the instrument is in Search Mode, it only samples when you activate sampling. When you see the display that says, “Ready...Start sampling?” press [Y/+] to start. The pump turns on and the instrument begins collecting data. To stop sampling, press [N/-] while the main display is showing. You will see a new screen that says, “Stop sampling?” Press [Y/+] to stop sampling. Press [N/-] if you want sampling to continue.

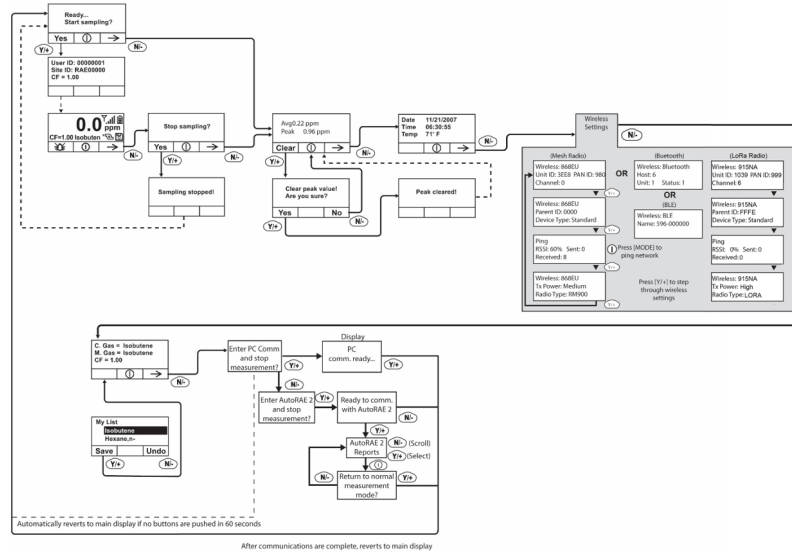

Note: Dashed line indicates automatic progression.

Advanced user level & search mode

With the instrument in Operation Mode: Search Mode, enter User Mode and select Advanced User Level (refer to the section called Monitor Mode for instructions). Operation is similar to Basic User Level & Sampling Mode, but now allows you to change calibration and measurement reference gases. Refer to the section on measurement gases for more details.

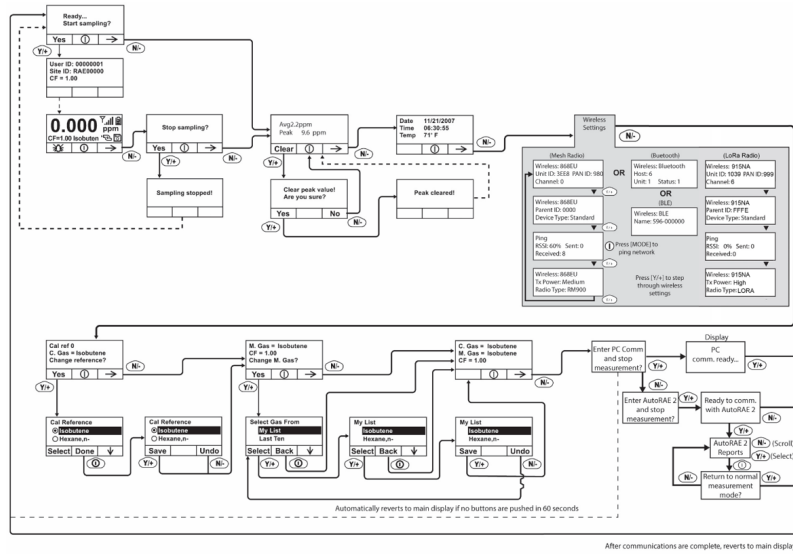

Note: Dashed line indicates automatic progression.

IMPORTANT!

Diagnostic Mode is designed for servicing and manufacturing, and therefore is not intended for everyday use, even by advanced users. It provides raw data from sensors and about settings, but only allows adjustment of pump stall parameters, which should only be changed by qualified personnel.

Note: If the instrument is turned on in Diagnostic Mode and you switch to User Mode, datalog data remains in raw count form. To change to standard readings, you must restart the instrument.

Entering diagnostic mode

Note: To enter Diagnostic Mode, you must begin with the instrument turned off.

Press and hold [Y/+] and [MODE] until the instrument starts.

The instrument goes through a brief startup, then asks for a password (default password is 0000), and then displays raw data for the PID sensor. These numbers are raw sensor readings without calibration. The instrument is now in Diagnostic Mode.

Note: In Diagnostic Mode, the pump and lamp are normally on.

You can enter Programming Mode and calibrate the instrument as usual by pressing both [MODE] and [N/-] for three seconds.

You can enter Monitoring Mode by pressing [MODE] and [Y/+] together for three seconds.

Once the instrument is started up in Diagnostic Mode, you can switch between Diagnostic Mode and Monitoring Mode by pressing and holding [MODE] and [Y/+] simultaneously for two seconds.

In Diagnostic mode, you can step through parameter screens by pressing [MODE].

Adjusting the pump stall threshold

If the gas inlet is blocked but the pump does not shut down, or the pump shuts down too easily with a slight blockage, the pump stall threshold value may be set too high or too low. Use the following steps to adjust the pump stall threshold:

Pump High

1. In Diagnostic Mode, press the [MODE] key repeatedly until “Pump High” is displayed. The display shows the maximum, minimum, and stall values for the pump at its high speed. Write down the “Max” reading.
 2. Block the gas inlet and watch the pump current reading (labeled “I”) increase. Write down its blocked reading.
- Note:** If the pump current reading does not increase significantly (less than 10 counts), then there may be a leak in the gas inlet or the pump is weak or defective.
3. Add the two readings you wrote down. This is the average of the maximum block count and the maximum idle count. Divide that number by 2. Use the [Y/+] or [N/] key to increase or decrease the stall value to equal that number.
 4. Press the [MODE] key to exit this display.

Note: the instrument will automatically save the last stall value.

Pump Low

1. In Diagnostic Mode, press the [MODE] key until “Pump Low” is displayed. The display shows the maximum, minimum, and stall values for the pump at its low speed. Write down the “Max” reading.
 2. Block the gas inlet and watch the pump current reading (labeled “I”) increase. Write down its blocked reading.
- Note:** If the pump current reading does not increase significantly (less than 10 counts), then there may be a leak in the gas inlet or the pump is weak or defective.
3. Add the two readings you wrote down. This is the average of the maximum block count and the maximum idle count. Divide that number by 2. Use the [Y/+] or [N/] key to increase or decrease the stall value to equal that number.
 4. Press the [MODE] key to exit this display.

Testing the humidity sensor

1. Press [MODE] to step through the diagnostic screens until you reach a screen that says “THP” (for “temperature, humidity, pressure,” although pressure is not supported) at the top.

There are three numbers for the humidity reading (“H”). The first number is the current humidity reading from the sensor. The second and third number are not used.

T.H.P.	
T	253
H	707 13109 13288
P	413
S/N	GHTJ1W0200

2. Fill a cup with warm water (>25° C/77° F).
3. Put a filter on the 3G PID's inlet probe.
4. Place the inlet probe over the warm water.
5. Cover the cup with your hand.

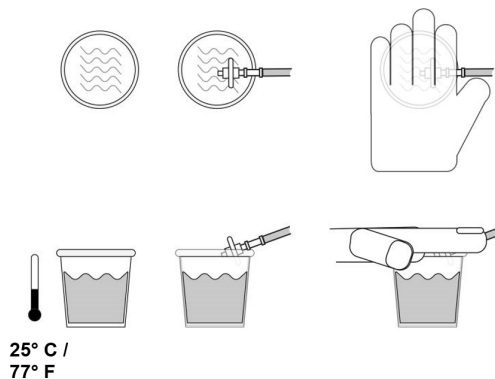

6. Wait a few seconds and check the high-humidity reading.
7. Verify that the first value increases. If it does not, then the THP Sensor (part number 023-3011-000-FRU) should be replaced.
8. Check the low-humidity reading by connecting the inlet probe to a tank of zero gas (air at 0% humidity).
9. Turn on the zero gas and wait a few seconds for the sensor reading to stabilize. Verify that the first number decreases. If it does not, the THP sensor should be replaced.
10. Once you have finished testing the humidity sensor, exit Diagnostic Mode by shutting down the instrument (hold [MODE] through the countdown, and then release when it is off).

Exiting diagnostic mode

You can exit Diagnostic Mode and go directly to Programming Mode or Monitor Mode as outlined above, or you can exit Diagnostic Mode completely.

To exit Diagnostic Mode so that it cannot be re-entered without a restart:

Shut down the instrument. When it is off, restart it by holding the [MODE] key. Diagnostic Mode cannot be entered until the instrument is restarted as outlined in “Entering Diagnostic Mode.”

Transferring data to & from a computer

Once you have connected your instrument Charging cradle, travel charger or AutoRAE 2 to the PC, you can transfer data, including a download of the datalog to the computer and updates of firmware to the instrument (should this ever be necessary).

Downloading the datalog to a PC

1. Connect the data cable to the PC and the Charging cradle
2. Place the instrument into its Charging cradle. The charging LED should be illuminated.
3. Use the N/- key to scroll to the “Enter PC Comm and Stop measurement” screen.
4. Select Yes with Y/+ key
5. Start Safety Suite Device Configurator (SSDC) on your PC.
6. Select the “check box” next to the serial number...
7. Click “Download Data” to receive the datalog data to the PC.
8. Allow download to complete (may take 5-12 minutes to complete)
9. Select data to be viewed from the blue menu bar – Event Log, Datalog, Export Datalog

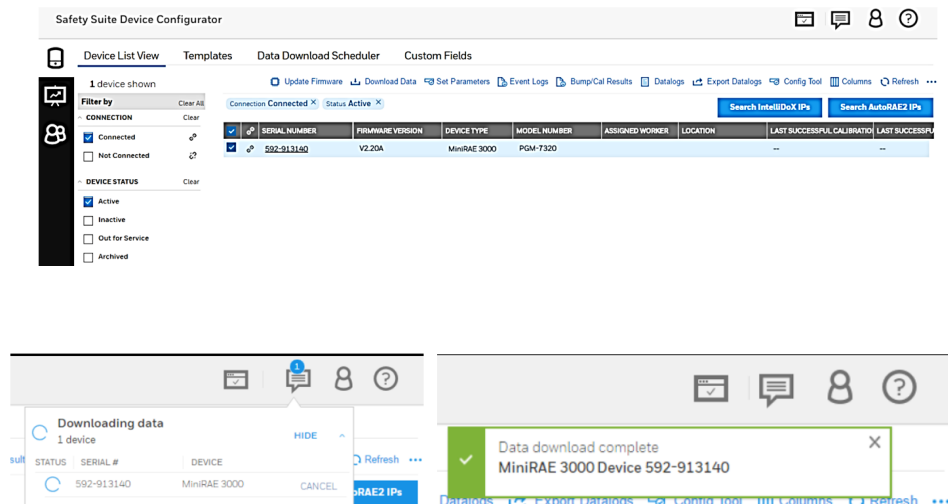

Uploading firmware to the instrument from a PC

Uploading new firmware to your instrument requires connecting the instrument and PC. Follow these steps to make the connection:

1. Connect the data cable to the PC and the Charging cradle.
2. Place the instrument into its Charging cradle. The charging LED should be illuminated.
3. Use the N/- key to scroll to the “Enter PC Comm and Stop measurement” screen.
4. Select Yes with Y/+ key.

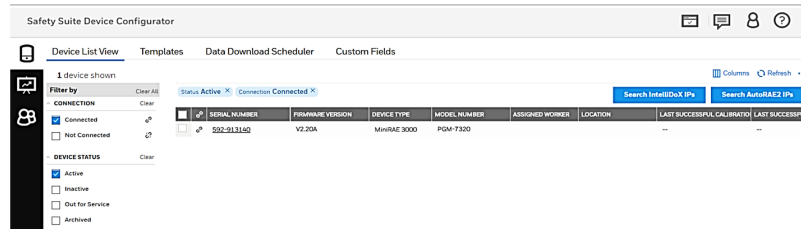

5. Click on the connected device’s serial number
6. Click “UPDATE.”
7. Select “Proceed.”
8. When the instrument powers OFF, the upload is complete.

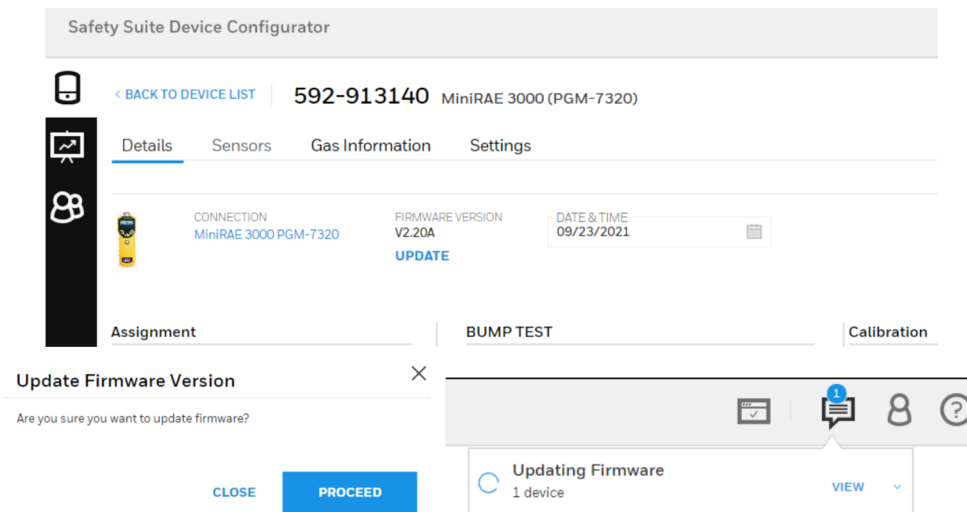

NOTE: If connected to the Internet, Safety Suite DC or Safety Suite DM provides the latest firmware automatically. If not connected to the internet, click on Update and manually add the latest firmware from Honeywell’s website. - sps.honeywell.com/us/en/software

20 MAINTENANCE

The major maintenance items of the instrument are:

- Battery pack
- PID sensor
- PID lamp
- Sampling pump
- Inlet connectors and filters

Note: Maintenance should be performed by qualified personnel only.

Note: The printed circuit board of the instrument is connected to the battery pack even if the power is turned off. Therefore, it is very important to disconnect the battery pack before servicing or replacing any components inside the instrument. Severe damage to the printed circuit board or battery may occur if the battery pack is not disconnected before servicing the unit.

Battery charging & replacement

When the display shows a flashing empty battery icon, the battery requires recharging. It is recommended to recharge the instrument upon returning from fieldwork. A fully charged battery runs an instrument for 16 hours continuously. The charging time is less than 8 hours for a fully discharged battery. The battery may be replaced in the field (in areas known to be non-hazardous), if required.



WARNING

To reduce the risk of ignition of hazardous atmospheres, recharge battery only in area known to be non-hazardous. Remove and replace battery only in areas known to be non-hazardous.

Replacing the Li-ion battery

1. Turn off the instrument.
2. Located on the rear of the instrument is a battery tab. Slide it down to unlock the battery.

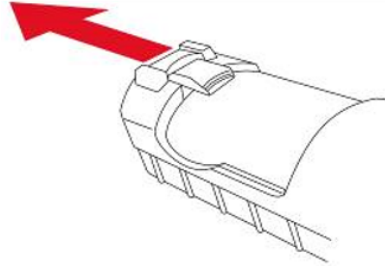

3. Remove the battery pack from the battery compartment by tilting it out.

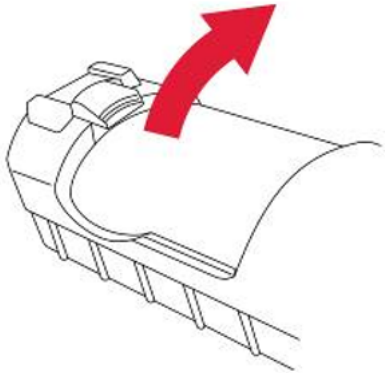

4. Replace a fully charged spare battery pack inside the battery compartment. Make sure the battery pack is oriented properly inside the compartment.
5. Slide the capture tab back up to its locked position.

Replacing the alkaline battery adapter

An alkaline battery adapter is supplied with each instrument. The adapter (part number 059-3052-000) accepts four AA alkaline batteries (use only Duracell MN1500) and provides approximately 12 hours of operation. The adapter is intended to be used in emergency situations when there is no time to charge the Li-ion battery pack.

To insert batteries into the adapter:

1. Remove the three Philips-head screws to open the compartment.
2. Insert four fresh AA batteries as indicated by the polarity (+/-) markings.
3. Replace the cover. Replace the three screws.

To install the adapter in the instrument:

1. Remove the Li-ion battery pack from the battery compartment by sliding the tab and tilting out the battery.
2. Replace it with the alkaline battery adapter
3. Slide the tab back into place to secure the battery adapter.

IMPORTANT!

Alkaline batteries cannot be recharged. The instrument's internal circuit detects alkaline batteries and will not allow recharging. If you place the instrument in its Charging cradle, the alkaline battery will not be recharged. The internal charging circuit is designed to prevent damage to alkaline batteries and the charging circuit when alkaline batteries are installed inside the instrument.

Note: When replacing alkaline batteries, dispose of old ones properly.



WARNING

To reduce the risk of ignition of hazardous atmospheres, recharge the battery only in areas known to be non-hazardous. Remove and replace the battery only in areas known to be non-hazardous.

Note: The internal charging circuit is designed to prevent charging to alkaline batteries.

PID sensor & lamp cleaning/replacement

Sensor Components – MiniRAE 3000+, ppbRAE 3000+

The sensor module is made of several components and is attached to the lamp-housing unit as shown below.

Note: Most of the items listed below are service restricted and can only be purchased by an Authorized service distributor.

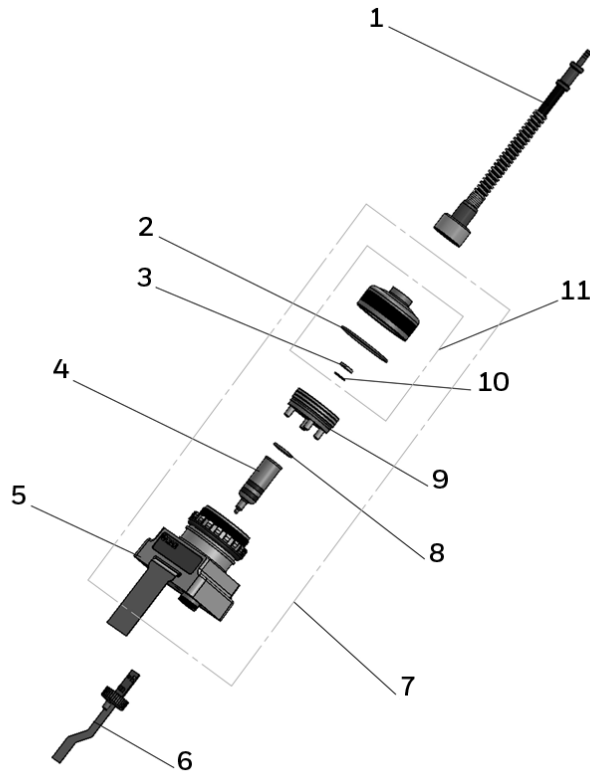

No.	Description	Part Number	No.	Description	Part Number
1	Inlet probe assembly	023-3012-000	7	Sensor module assembly*	023-3005-X00
2	O-ring, 35mm x 2mm		8	Teflon O-ring*	
3	Porous metal filter		9	PID sensor	023-3010-001
4	Lamp 1/2" (10.6eV)	050-0000-004	10	Filter fixer (included with Sensor cover assembly)	
5	Sensor body assembly		11	Sensor cover assembly*	023-3009-000-FRU
6	THP (temperature, humidity) sensor module*	023-3011-000		Filter and O-ring kit	023-3009-000

* These parts are service restricted

Sensor Components – UltraRAE 3000+

The sensor module is made of several components and is attached to the lamp-housing unit as shown below.

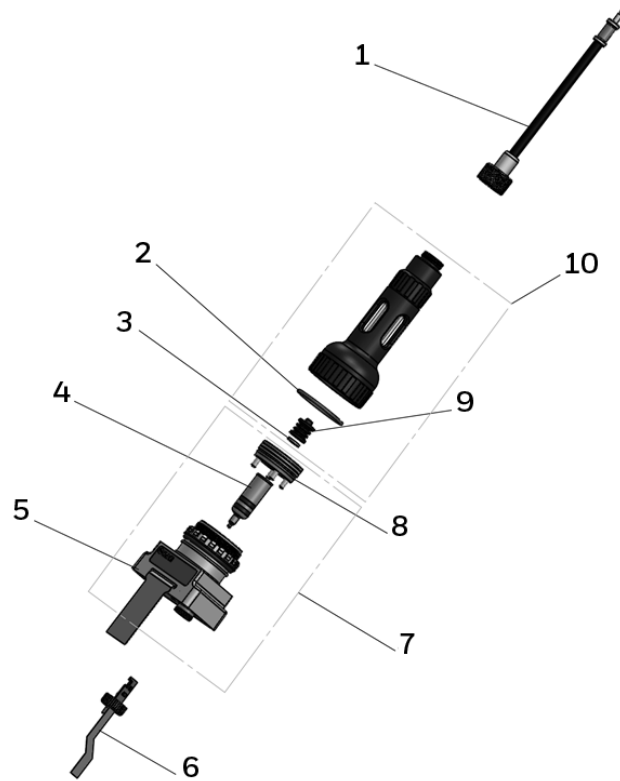

No.	Description	Part Number	No.	Description	Part Number
1	Inlet probe assembly	023-3012-000	7	Sensor module assembly*	023-3005-X00
2	O-ring, 35mm x 2mm		8	PID sensor	023-3010-001
3	Porous metal filter		9	Rubber adapter	
4	Lamp 1/2" (9.8eV)	050-0020-000	10	Tube adapter assembly	059-3015-000
5	Sensor body assembly			Filter and O-ring kit	023-3009-000
6	THP (temperature, humidity) sensor module*	023-3011-000			

* These parts are service restricted

Note: The cleaning procedure is not normally needed. Clean the PID sensor module, the lamp and the lamp housing only when one of the following has happened:

1. The reading is inaccurate even after calibration.
2. The reading is very sensitive to air moisture.
3. A chemical liquid has been sucked into the unit and damaged the unit.

Use of the external filter helps to prevent contamination of the sensor.

To access the sensor components and lamp, gently unscrew the lamp-housing cap, remove the sensor adapter with the gas inlet probe and the metal filter all together. Then hold the PID sensor and pull it straight out. A slight, gentle rocking motion helps release the sensor.

Sensor Components – MiniRAE Lite+

The sensor module is made of several components and is attached to the lamp-housing unit as shown below.

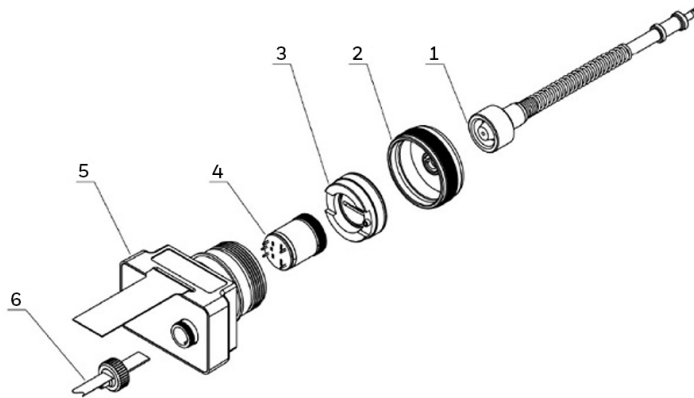

No.	Description	Part Number	No.	Description	Part Number
1	Inlet probe	023-3012-000	4	Sensor 4GPID	C08-0902-002
2	Sensor cover assembly	023-3009-000-FRU	5	Sensor module assembly	3011-2788-001
3	Gas plate	3011-2793-001	6	THP sensor	023-3011-000

Cleaning the PID sensor

Place the entire PID sensor module into GC grade methanol. It is highly recommended that an ultrasound bath to be used to clean the sensor for at least 15 minutes. Then dry the sensor thoroughly. Never touch the electrodes of the sensor by hand.

Also use a methanol-soaked cotton swab to wipe off the lamp housing where it contacts the sensor when the sensor is installed.

Turn over the sensor so that the pins point up and the sensor cavity is visible. Examine the sensor electrodes for any corrosion, damage, or bending out of alignment. The metal sensor electrode “fingers” should be flat and straight. If necessary, carefully bend the sensor fingers to ensure that they do not touch the Teflon portions and that they are parallel to each other. Make sure that the nuts on the sensor pins are snug but not overtight. If the sensor is corroded or otherwise damaged, it should be replaced.

Cleaning the lamp housing or changing the lamp

If the lamp does not turn on, the instrument will display an error message to indicate replacement of the lamp may be required.

1. If the lamp is operational, clean the lamp window surface and the lamp housing by wiping it with GC grade methanol using a cotton swab using moderate pressure. After cleaning, hold the lamp up to the light at an angle to detect any remaining film. Repeat the process until the lamp window is clean. Never use water solutions to clean the lamp. Dry the lamp and the lamp housing thoroughly after cleaning.



CAUTION

Never touch the window surface with the fingers or anything else that may leave a film. Never use acetone or aqueous solutions.

2. If the lamp does not turn on, remove the lamp from the lamp housing. Place the lamp O-ring onto the new lamp. Insert the new lamp, avoiding contact with the flat window surface.
3. Reinstall the PID sensor module.
4. Tighten the Lamp Housing Cap.

Determining the lamp type

Note: This feature is not included on the MiniRAE Lite+.

The monitor may be able to accommodate three lamp values: 9.8eV, 10.6eV (standard) and 11.7eV.

There are two ways to determine the lamp type.

1. Turn off the instrument and remove the lamp. Now look at the serial number. The following identify the lamp type:
 - 10.6eV: SN:106 XXXXXXXX
 - 9.8eV: SN:098 XXXXXXXX
 - 11.7eV: SN:117 XXXXXXXX (available for UltraRAE 3000+ and MiniRAE 3000+)
2. When the monitor is running, the lamp type is shown along with the calibration and measurement gas and Correction Factor:

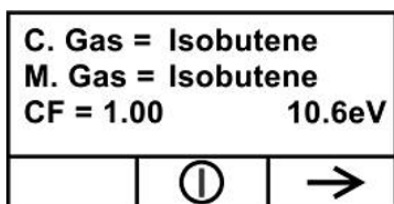

3. Note: This screen can be accessed from the reading screen by pressing [N/-] four times.

IMPORTANT!

When using an 11.7eV lamp, refer to TN-207 for the calibration process.

Programming the lamp ID

The correct measurement gas library is used by the instrument when you ensure that the right lamp value is programmed.

To manually select the Lamp ID:

1. Enter the Programming menu.
2. Select Monitor Setup.
3. Scroll down and select the Lamp ID sub-menu.
4. Press [N/-] to scroll down to the desired Lamp ID.
5. Press [Y/+] to select.
6. Press [MODE] to select Done.
7. Select "Save."
8. Return to the main menu.

Recalibrate the instrument before returning it to service.

Sampling pump

When approaching the end of the specified lifetime of the pump, it will consume higher amount of energy and reduce its sample draw capability significantly. When this occurs, it is necessary to replace or rebuild the pump. When checking the pump flow, make sure that the inlet connector is tight and the inlet tubing is in good condition. Connect a flow meter to the gas inlet probe. The flow rate should be above 450 cc/min when there is no air leakage.

If the pump is not working properly, refer the instrument to qualified service personnel for further testing and, if necessary, pump repair or replacement.

Cleaning the instrument

Occasional cleaning with a soft cloth is recommended. Do not use detergents or chemicals.

Visually inspect the contacts at the base of the instrument, on the battery, and on the Charging cradle to make sure they are clean. If they are not, wipe them with a soft, dry cloth. Never use solvents or cleaners.

Special servicing note

If the instrument needs to be serviced, contact either:

1. The Honeywell distributor from whom the instrument was purchased; they will return the instrument on your behalf.
or
2. The Honeywell Technical Service Department. Before returning the instrument for service or repair, obtain a Returned Material Authorization (RMA) number for proper tracking of your equipment. This number needs to be on all documentation and posted on the outside of the box in which the instrument is returned for service or upgrade. Packages without RMA Numbers will be refused at the factory.

MiniRAE Lite+ specifications

Size:	25.5cm x 7.6cm x 6.4cm / 9.25" L x 3.6" W x 2.9" H	
Weight:	738g /28oz with battery pack	
Detector:	Photoionization sensor with 10.6 eV UV lamp	
Battery:	Rechargeable Lithium-Ion battery pack (snap in, field replaceable) Alkaline battery holder (for 4 AA batteries)	
Battery Charging:	Less than 8 hours to full charge	
Operating Hours:	Non-wireless	Up to 16 hours continuous operation with rechargeable battery Up to 12 hours with alkaline battery
	Wireless	Up to 13 hours continuous operation with rechargeable battery
Display:	Large dot matrix screen with backlight	

Measurement range & resolution

Lamp	Range	Resolution
10.6 eV	0.1 ppm to 5,000 ppm	0.1 ppm

Response time (T₉₀): 2 seconds
 Accuracy (Isobutylene): 10 to 2000 ppm: ±5% at calibration point.
 PID Detector: Easy access to lamp and sensor for cleaning and replacement
 Calibration: Two-point field calibration of zero and standard reference gases
 Patented Reflex PID™ technology
 Inlet Probe: Flexible 5" tubing
 Keypad: 1 operation key and 2 programming keys; 1 flashlight switch
 Direct Readout: Instantaneous, peak value, and battery voltage
 Datalogging: 260,000 points with time stamp, serial number, user ID, site ID, etc.

Intrinsic Safety: ATEX



IECEX

Sira 17ATEX2082X
 CSA 10.0005X Ex ia IIC T4 Gb
 Ex ia IIB T4 Gb
 EX ia IIC T4 Gb (with bat pack 059-3051-000)
 EX ia IIB T4 Gb (with bat pack 059-3052-000)



CSAE 21UKEX2051X



EM Interference: Highly resistant to EMI/RFI.
 Alarm Setting: Separate alarm limit settings for Low Alarm and High Alarm
 Alarm: Buzzer 95dB at 30cm and flashing red LEDs to indicate exceeded preset limits, low battery voltage, or sensor failure
 Alarm Type: Latching or automatic reset
 Real-time Clock: Automatic date and time
 Communication: Download instrument setup from PC via RS-232 with Travel Charger, or via USB with optional Charger Stand
 Upload data to PC and download instrument setup from PC via USB on charging station.
 Enhanced datalogging capability through BLE module and mobile app
 Sampling Pump: Internally integrated. Flow rate: 450 to 550 cc/min.
 Temperature: -20° C to 50° C (-4° to 122° F)
 Humidity: 0% to 95% relative humidity (non-condensing)
 Housing (including rubber boot): Polycarbonate, splashproof and dustproof
 Battery can be changed without removing rubber boot.

MiniRAE 3000+ specifications

Size:	25.5cm x 7.6cm x 6.4cm (9.25" L x 3.6" W x 2.9" H)	
Weight:	738g / 28oz with battery pack	
Detector:	Photoionization sensor with 9.8, 10.6, or 11.7 eV UV lamp	
Battery:	A 3.7V rechargeable Lithium-Ion battery pack (snap in, field replaceable, at non-hazardous location only) Alkaline battery holder (for 4 AA batteries)	
Battery Charging:	Less than 8 hours to full charge	
Operating Hours:	Non-wireless	Up to 16 hours continuous operation with rechargeable battery Up to 12 hours with alkaline battery
	Wireless	Up to 13 hours continuous operation with rechargeable battery
Display:	Large dot matrix screen with backlight	

Measurement range & resolution

Lamp	Range	Resolution
10.6 eV	0 to 999.9 ppm 1,000 to 15,000 ppm	0.1 ppm 1ppm
9.8 eV	0.1 ppm to 5,000 ppm	0.1 ppm
11.7 eV	0.1 ppm to 2,000 ppm	0.1 ppm

Response time (T ₉₀):	2 seconds	
Accuracy (Isobutylene):	10 to 2000 ppm: ±3% at calibration point.	
PID Detector:	Easy access to lamp and sensor for cleaning and replacement	
Correction Factors:	Over 200 VOC gases built in	
Calibration:	Two-point field calibration of zero and standard reference gases Patented Reflex PID™ technology	
Calibration reference:	Store up to 8 sets of calibration data, alarm limits, and span values	
Inlet Probe:	Flexible 5" tubing	
Radio module:	BLE (2.4GHz), Bluetooth (2.4GHz) or RF module (868MHz or 915MHz)	
Keypad:	1 operation key and 2 programming keys; 1 flashlight switch	
Direct Readout:	Instantaneous, average, STEL, TWA and peak value, and battery voltage	
Intrinsic Safety:	ATEX	   II 2G Ex ia IIC T4 Gb Ex ia IIB T4 Gb Sira 17ATEX2082X CSA 10.0005X Ex ia IIC T4 Gb Ex ia IIB T4 Gb IECEX EX ia IIC T4 Gb (with bat pack 059-3051-000) EX ia IIB T4 Gb (with bat pack 059-3052-000) UK CA ₈₅₀₁ CSAE 21UKEX2051X CSAE 21UKEX2051X
EM Interference:	Highly resistant to EMI/RFI. Compliant with EMC RE-D (RF Modules)	
Alarm Setting:	Separate alarm limit settings for Low, High, STEL, and TWA alarm	
Operating Mode:	Hygiene or Search mode	
Alarm:	Buzzer 95dB at 30cm and flashing red LEDs to indicate exceeded preset limits, low battery voltage, or sensor failure	
Alarm Type:	Latching or automatic reset	
Real-time Clock:	Automatic date and time stamps on datalogged information	
Communication:	Upload data to PC and download instrument setup from PC via USB on charging station. Enhanced datalogging capability through BLE module and mobile app	
Sampling Pump:	Internally integrated. Flow rate: 450 to 550 cc/min.	
Wireless Network:	Mesh RAE Systems Dedicated Wireless Network (or Wi-Fi/LoRa network for Wi-Fi/LoRa-equipped instruments) Bluetooth Low energy	
Wireless Frequency:	ISM license-free band, 902 to 907.5 MHz and 915 to 928 MHz, FCC Part 15, CE RE-D IEEE 802.11 b/g bands (2.4 GHz)	
Modulation:	802.15.4 DSSS BPSK	
RF Power (Tx):	10dBm	
Temperature:	-20° C to 50° C (-4° to 122° F)	

Humidity: 0% to 95% relative humidity (non-condensing)

Housing (including rubber boot): Polycarbonate, splashproof and dustproof



Battery can be changed without removing rubber boot.

ppbRAE 3000+ specifications

Size:	25.5cm x 7.6cm x 6.4cm (9.25" L x 3.6" W x 2.9" H)	
Weight:	738g / 28oz with battery pack	
Detector:	Photoionization sensor with 9.8eV or 10.6eV UV lamp	
Battery:	A 3.7V rechargeable Lithium-Ion battery pack (snap in, field replaceable, at non-hazardous location only) Alkaline battery holder (for 4 AA batteries)	
Battery Charging:	Less than 8 hours to full charge	
Operating Hours:	Non-wireless	Up to 16 hours continuous operation with rechargeable battery Up to 12 hours with alkaline battery
	Wireless	Up to 13 hours continuous operation with rechargeable battery
Display:	Large dot matrix screen with backlight	

Measurement range & resolution

Lamp	Range	Resolution
10.6 eV	0 to 9999 ppb 10 to 99 ppm 100 to 99 ppm 1000 to 9999 ppm	1 ppb 0.01 ppm 0.1 ppm 1 ppm
9.8 eV	0.1 ppm to 5,000 ppm	10 ppb

Response time (T ₉₀):	2 seconds	
Accuracy (Isobutylene):	10 to 2000 ppm: ±3% at calibration point.	
PID Detector:	Easy access to lamp and sensor for cleaning and replacement	
Correction Factors:	Over 200 VOC gases built in	
Calibration:	Two-point field calibration of zero and standard reference gases Patented Reflex PID™ technology	
Calibration reference:	Store up to 8 sets of calibration data, alarm limits, and span values	
Inlet Probe:	Flexible 5" tubing	
Radio module:	BLE (2.4GHz), Bluetooth (2.4GHz) or RF module (868MHz or 915MHz)	
Keypad:	1 operation key and 2 programming keys; 1 flashlight switch	
Direct Readout:	Instantaneous, average, STEL, TWA and peak value, and battery voltage	
Intrinsic Safety:	ATEX	  II 2G Ex ia IIC T4 Gb Ex ia IIB T4 Gb Sira 17ATEX2082X CSA 10.0005X Ex ia IIC T4 Gb Ex ia IIB T4 Gb IECEX EX ia IIC T4 Gb (with bat pack 059-3051-000) EX ia IIB T4 Gb (with bat pack 059-3052-000)  CSAE 21UKEX2051X CSAE 21UKEX2051X
EM Interference:	Highly resistant to EMI/RFI. Compliant with EMC RE-D (RF Modules)	
Alarm Setting:	Separate alarm limit settings for Low, High, STEL, and TWA alarm	
Operating Mode:	Hygiene or Search mode	
Alarm:	Buzzer 95dB at 30cm and flashing red LEDs to indicate exceeded preset limits, low battery voltage, or sensor failure	
Alarm Type:	Latching or automatic reset	
Real-time Clock:	Automatic date and time stamps on datalogged information	
Datalogging:	260,000 points with time stamp, serial number, user ID, site ID, etc.	
Communication:	Upload data to PC and download instrument setup from PC via USB on charging station. Enhanced datalogging capability through BLE module and mobile app	
Wireless Network:	Mesh RAE Systems Dedicated Wireless Network (or Wi-Fi/LoRa network for Wi-Fi/LoRa-equipped instruments) Bluetooth Low Energy (BLE) module	
Sampling Pump:	Internally integrated. Flow rate: 450 to 550 cc/min.	
Wireless Frequency:	ISM license-free band, 902 to 907.5 MHz and 915 to 928 MHz, FCC Part 15, CE RE-D	
Modulation:	802.15.4 DSSS BPSK	
RF Power (Tx):	10dBm	
Temperature:	-20° C to 50° C (-4° to 122° F)	

Humidity: 0% to 95% relative humidity (non-condensing)

Housing (including rubber boot): Polycarbonate, splashproof and dustproof



Battery can be changed without removing rubber boot.

UltraRAE 3000+ specifications

Size:	25.5 cm x 7.6 cm x 6.4 cm (10" L x 3" W x 2.5" H)	
Weight:	26 oz (738 g) with battery pack	
Detector:	Photoionization sensor with 9.8, 10.6, or 11.7 eV UV lamp	
Battery:	A 4.2V rechargeable Lithium-Ion battery pack (snap in, field replaceable, at non-hazardous location only) Alkaline battery holder (for 4 AA batteries)	
Battery Charging:	Less than 8 hours to full charge	
Operating Hours:	Non-wireless	Up to 16 hours continuous operation with rechargeable battery Up to 12 hours with alkaline battery
	Wireless	Up to 13 hours continuous operation with rechargeable battery
Display:	Large dot matrix screen with backlight	

Measurement range & resolution

Lamp	Range	Resolution
10.6 eV (TVOC)	10 ppb 0.1 ppm 1 ppm	10 ppb 0.1 ppm 1 ppm
9.8 eV (TVOC) 9.8 eV (Benzene butadiene)	0 to 5000 ppm 10 ppb to 200 ppm	10 ppb 10 ppm

Response time (T ₉₀):	2 seconds	
Accuracy (Isobutylene):	3% at calibration point	
PID Detector:	Easy access to lamp and sensor for cleaning and replacement	
Correction Factors:	Over 200 VOC gases built in	
Calibration:	Two-point field calibration of zero and standard reference gases Patented Reflex PID™ technology	
Calibration reference:	Store up to 8 sets of calibration data, alarm limits, and span values	
Inlet Probe:	Flexible 5" tubing (a short tube is also available) Separation tube housing with permanent VOC tube	
Radio module:	BLE (2.4GHz), Bluetooth (2.4GHz) or RF module (868MHz or 915MHz)	
Wireless Network:	Mesh RAE Systems Dedicated Wireless Network (or Wi-Fi/LoRa network for Wi-Fi/LoRa-equipped instruments) Bluetooth Low Energy (BLE) module	
Wireless Frequency:	ISM license-free band, 902 to 907.5 MHz and 915 to 928 MHz, FCC Part 15, CE RE-D	
Modulation:	802.15.4 DSSS BPSK	
RF Power (Tx):	10dBm	
Keypad:	1 operation key and 2 programming keys; 1 flashlight switch	
Direct Readout:	Instantaneous, average, STEL, TWA and peak value, and battery voltage	
Intrinsic Safety:	ATEX	   II 2G Ex ia IIC T4 Gb Ex ia IIB T4 Gb Sira 17ATEX2082X CSA 10.0005X Ex ia IIC T4 Gb Ex ia IIB T4 Gb IECEX EX ia IIC T4 Gb (with bat pack 059-3051-000) EX ia IIB T4 Gb (with bat pack 059-3052-000) UK CA <small>8501</small> CSAE 21UKEX2051X CSAE 21UKEX2051X
EM Interference:	Highly resistant to EMI/RFI. Compliant with EMC RE-D (RF Modules)	
Alarm Setting:	Separate alarm limit settings for Low, High, STEL, and TWA alarm	
Operating Mode:	Hygiene or Search mode	
Alarm:	Buzzer 95dB at 12" (30cm) and flashing red LEDs to indicate exceeded preset limits, low battery voltage, or sensor failure	
Alarm Type:	Latching or automatic reset	
Real-time Clock:	Automatic date and time stamps on datalogged information	
Datalogging:	260,000 points with time stamp, serial number, user ID, site ID, etc.	
Communication:	Upload data to PC and download instrument setup from PC via USB on charging station. Enhanced datalogging capability through BLE module and mobile app	
Sampling Pump:	Internally integrated. Flow rate: 450 to 550 cc/min.	

Temperature: -20° C to 50° C (-4° to 122° F)
Humidity: 0% to 95% relative humidity (non-condensing)
Housing (including rubber boot): Polycarbonate, splashproof and dustproof
Battery can be changed without removing rubber boot.

Problem	Possible Reasons & Solutions	
Cannot turn on power after charging the battery	Reasons	Discharged battery. Defective battery.
	Solutions	Charge or replace battery.
Lost password	Solutions	Call Technical Support toll-free at +1 888-749-8878
Reading abnormally high	Reasons	Dirty filter. Dirty sensor module. Excessive moisture and water condensation. Incorrect calibration.
	Solutions	Replace filter. Blow-dry the sensor module. Calibrate the unit.
Reading abnormally low	Reasons	Dirty filter. Dirty sensor module. Weak or dirty lamp. Incorrect calibration.
	Solutions	Replace filter. Remove Calibration Adapter. Calibrate the unit. Check for air leakage.
Buzzer inoperative	Reasons	Bad buzzer.
	Solutions	Check that buzzer is not turned off. Call authorized service center.
Inlet flow too low	Reasons	Pump diaphragm damaged or has debris. Flow path leaks.
	Solutions	Check flow path for leaks; sensor module O-ring, tube connectors, Teflon tube compression fitting. Call Technical Support toll-free at +1 888-749-8878

Problem	Possible Reasons & Solutions	
"Lamp" message during operation	Reasons	Lamp drive circuit. Weak or defective PID lamp, defective.
	Solutions	Turn the unit off and back on. Replace UV lamp
"Sen" message during operation	Reasons	Lamp drive circuit. Weak or defective PID lamp. Sensor defective.
	Solutions	Turn the unit off and replace the sensor. Or replace UV lamp of sensor. Or replace detector of sensor

Contact

Corporate Headquarters

Honeywell

700 Mint St.

Charlotte, NC 28202, USA

Phone : +1 888 749 8878

rae-callcenter@honeywell.com

Worldwide Sales Offices

USA/Canada 1.877.723.2878

Europe +800.333.222.44/+41.44.943.4380

Middle East +971.4.450.5852

China +86.10.5885.8788-3000

Asia Pacific +852.2669.0828



User Manual059-4026-000

Language: English

Revision C

@ 2022Wednesday, February 22, 2023

CoE CDMX